



ANNO 1873

**DE PYPERE**











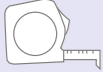
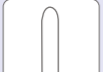







MADE IN BELGIUM

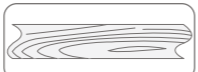

SPADEN ■ GEREEDSCHAP VOOR BOSBOUW ■ HAKKEN ■ HARKEN ■ SNOEIGEREEDSCHAP ■ VORKEN ■ SCHOPPEN ■ TRUW  
ACCES ■ BECHES ■ BOIS ET FORET ■ HOUES ■ RATEAUX ■ FOURCHES ■ PELLES ■ TRUELLES ■ OUTILS POUR LA CONSTRUCT





	Afmeting Dimension		L-steel Manche L		Stift Soie		PVC steel met glasvezelkern Manche PVC avec noyau en fibre de verre
	Steel type Type de manche		T-steel Manche T		Dul Douille		Glasvezelsteel pro Manche en fibre de verre Professionnel
	Presentatie Présentation		D-steel Manche D		Lipdul Douille a patte		Steel Hickory Manche Hickory
	verpakingsunit mode d'emballage		Bol-steel Manche boule				Steel Es Manche Frêne
	bladlengte Longueur de la lame						Steel Beuk Manche Hêtre
	gewicht poids						
	Verbindingstype Type d'assemblage						
	Steel referentie Référence de manche						
	bladdikte épaisseur de la lame						

## Het bedrijf . L' entreprise

Sinds 1873 is **De Pypere** fabrikant van kwalitatief handgereedschap voor land- en tuinbouw, bouwindustrie en DIY-sector. Deze vele jaren ervaring maakt **De Pypere** meteen ook uniek in België. Samen met haar zusterbedrijven, Metafox en Maes Metal, stelt de groep Icarus een 90-tal mensen tewerk.

Naast de productie van de traditionele handgereedschappen kijkt **De Pypere** ook steeds uit naar nieuwe en vooruitstrevende producten, alsook naar vernieuwing en optimalisering van het bestaande assortiment. Trouw blijvend aan het ambachtelijke karakter en enkel gebruikmakend van de beste grondstoffen, staat **De Pypere** borg voor gereedschappen van een uitzonderlijke kwaliteit. Deze ver doorgedreven passie voor verzorgde kwaliteit en afwerking komen eveneens tot uiting in de verpakking en de presentatie van de producten. De strakke kleuren van de producten stralen een duurzame kwaliteit en klasse uit en trekken in de betere zaken de aandacht van de consument. Door haar dynamische aanpak kan **De Pypere** als KMO u meer service bieden dan de grotere industriële ondernemingen.

De flexibiliteit om zich aan de eisen van de klanten aan te passen, de vlotte communicatie en het brede assortiment producten met de juiste prijs-kwaliteitsverhouding, maakt **De Pypere** tot uw geschikte partner.

Depuis 1873, **De Pypere** est fabricant d'outillages à main de qualité supérieure destinés à l'agriculture, à l'horticulture, à l'industrie de la construction et au secteur du bricolage. Par ailleurs, ces nombreuses années d'expérience rendent **De Pypere** unique en Belgique. En liaison avec ses entreprises associées, Metafox et Maes Metal, le groupe Icarus emploie quelque 90 personnes.

Outre la production des outillages à main traditionnels, **De Pypere** cherche toujours à développer de nouveaux produits de pointe, ainsi qu'à renouveler et optimiser la gamme existante. Fidèle à l'artisanat et n'utilisant que des matériaux de première qualité, **De Pypere** vous garantit une gamme complète d'outils de qualité supérieure. La passion du bel outil se reflète dans l'emballage et la présentation attrayante des produits, qui ont une finition parfaite. Les teintes fixes des produits rayonnent la qualité durable et la classe et attirent l'attention du consommateur dans les meilleurs magasins. En tant que PME dynamique, **De Pypere** peut vous offrir un meilleur service que les grandes entreprises industrielles.

Grâce à sa flexibilité pour s'adapter aux exigences des clients, à la communication transparente et à l'offre d'une large gamme de produits au rapport qualité-prix optimal, **De Pypere** se présente comme votre partenaire idéal.

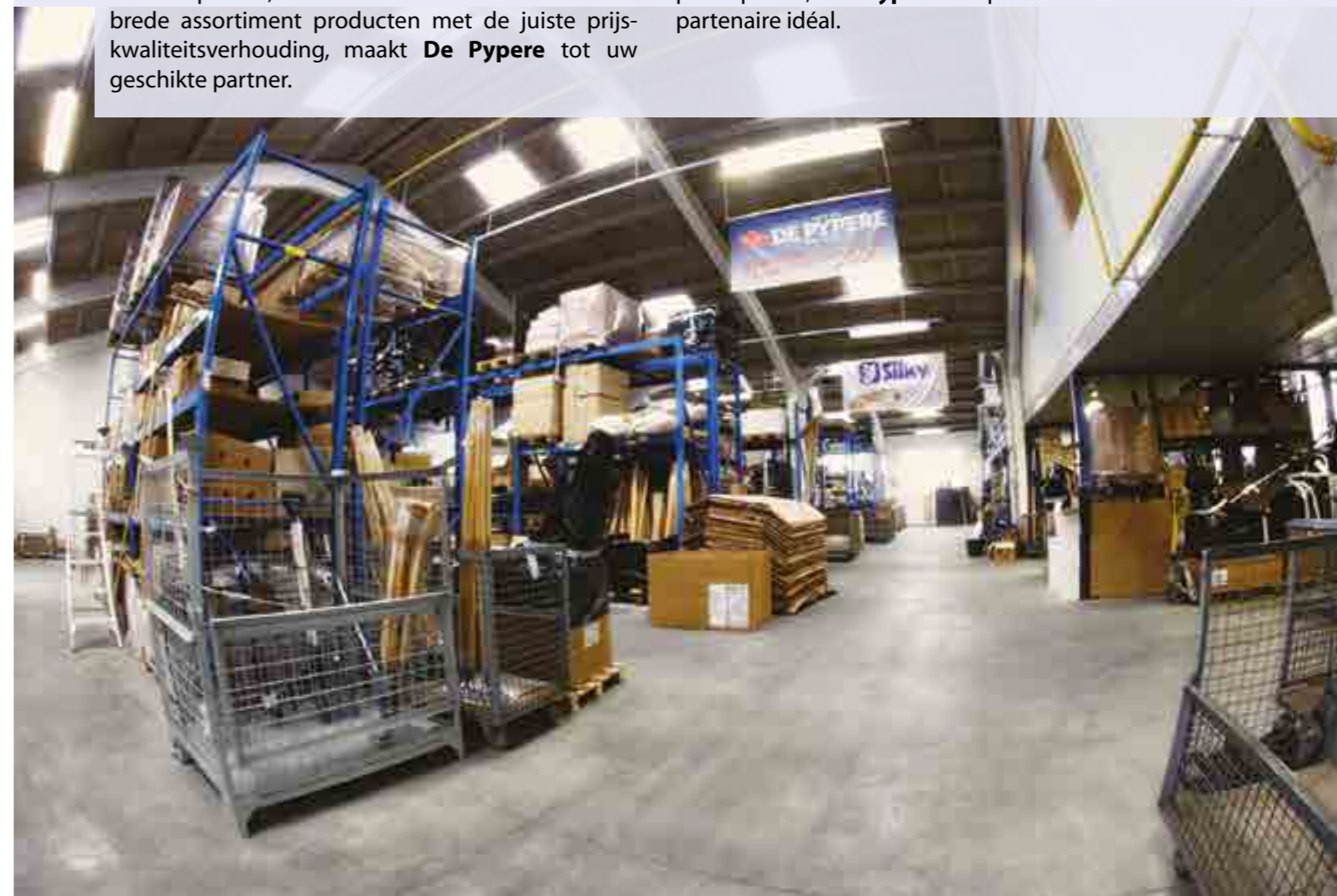





# Productie Production

4

Afschrikken in een oliebad  
Le trempage dans un bain d'huile

# Harden Tremper



Stansen van het spadeblad uit boorstaal  
Le découpage de la lame en acier au bore

# 1 Stansen Découper



# 5 Lassen Souder

Gerobotiseerd oplassen van de spadeleest  
Le soudage robotisé de la douille de la bêche



6

# Slijpen Polir

# 7 Klinken Riveter

Stelen van de spade  
Montage de la bêche

8

# Vernissen Vernir

Opwarmen tot een gloeitemperatuur van 850 °C  
L'échauffement jusqu'à une température de recuit de 850°C

Vormen van het spadeblad op de frictiepers  
La formation de la lame de bêche sur la presse à friction



**5 Jaar-Ans  
garantie**  
op het spadeblad  
sur la lame de bêche



# Index Contenu

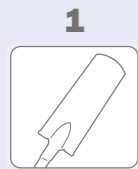

**1**  
**Spaden**  
**Bêches**  
pag. 1



**5**  
**Snoeigereedschappen**  
**Outils de taille**  
pag. 29

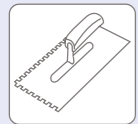

**9**  
**Metselen, vloeren & pleisteren**  
**Maçonnerie, carrelage & plâtrage**  
pag. 65



**13**  
**Borstels**  
**Brosses**  
pag. 89



**De Pypere Exclusive**  
**De Pypere Exclusive**  
pag. 112

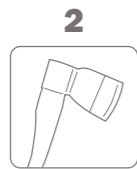

**2**  
**Gereedschap voor bosbouw**  
**Bois et forêt**  
pag. 7



**6**  
**Vorken**  
**Fourches**  
pag. 45



**10**  
**Gereedschap met glasvezelsteel**  
**Outils en fibre**  
pag. 73

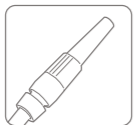

**14**  
**Sproeimateriaal**  
**Outils d'arrosage**  
pag. 95



**3**  
**Hakken en klein tuingereedschap**  
**Houes et petits outils de jardin**  
pag. 11



**7**  
**Schoppen**  
**Pelles**  
pag. 51



**11**  
**Kindergereedschap**  
**Outils pour enfants**  
pag. 76



**15**  
**Caddy's**  
**Caddy's**  
pag. 107

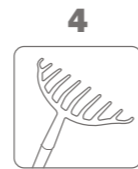

**4**  
**Harken en gazonafboorders**  
**Râteaux et coupe-bordures**  
pag. 22



**8**  
**Gereedschappen voor de bouw**  
**Outils pour la construction**  
pag. 56



**12**  
**Stelen en toebehoren**  
**Manches et accessoires**  
pag. 79



**16**  
**Starko**  
**Starko**  
pag. 110

## Spaden . Bêches



**Voordelen**  
**Avantages**

perfecte afwerking  
 finition parfaite

5 jaar garantie op het spadeblad  
 5 ans de garantie sur la lame de bêche

D-steel uit 1 stuk  
 Manche D d'une pièce

Geverniste essen steel  
 Manche vernie en frêne

Spadeblad van gehard staal  
Lame en acier trempé

1

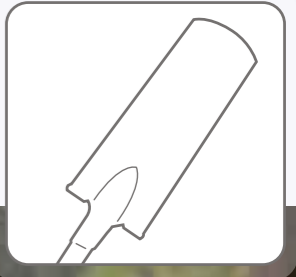

Gepolijste afwerking  
 Belle finition et polissage

extra licht  
 ultra léger

T-steel doorgewerkt in kruk  
 Manche T mortaisé

Stelbevestiging door 2 klinknagels  
 Fixation solide par 2 rivets





Spit- & tuinspaden / Bêches d'agriculture



101.T

**Spitspade 38/16**  
Louchet d'agriculture 38/16

art.nr.	mm	unit	ref.	kg.
101.T	380x160	5	M101.1	2,25
101.D	380x160	5	M102.1	2,25



101.D

**Spitspade traditioneel handgepolijst 38/14**  
Louchet d'agriculture traditionnelle poli à main 38/14

art.nr.	mm	unit	ref.	kg.
102.T	400x140	5	M101.1	2,25



104.T

**Spitspade 32/16**  
Louchet d'agriculture 32/16

art.nr.	mm	unit	ref.	kg.
104.T	320x160	5	M101.1	2,25
104.TF	320x160	5	M101.F	3



104.TF

**Spitspade 32/16 met bolsteel**  
Louchet d'agriculture 32/16 manche boule

art.nr.	mm	unit	ref.	kg.
104.B	320x160	5	M103.1	2,25



105.T

**Tuinspade met gebogen steel**  
Louchet jardin manche courbé

art.nr.	mm	unit	ref.	kg.
105.T	285x180	5	M101.6	2,25
105.FPT	285x180	5	FPM101	2,33



105.FPT

108.T

**Spade Limburg**  
Louchet Limbourg

art.nr.	mm	unit	ref.	kg.
108.B	260x180	5	M103.2	2,25
108.T	260x180	5	M101.6	2,25



108.B

**Spade Charleroi met gebogen steel**  
Louchet Charleroi avec manche courbé

art.nr.	mm	unit	ref.	kg.
110.T	300x180	5	M101.6	2,05



**Tuinspade klein**  
Louchet jardin

art.nr.	mm	unit	ref.	kg.
115.T	280x110	5	M101.2	2,05

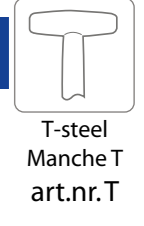
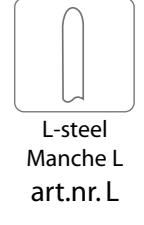

Grondwerkersspaden / Bêches terrassières

**Steeds met hoekijzeren voetsteun.**  
Toujours avec repose-pied soudé.



**Grondwerkersspade**  
Louchet terrassière

art.nr.	mm	unit	ref.	kg.
103.T34	340x140	5	M101.2	2,25
103.T40	400x140	5	M101.2	2,25
103.TF34	340x140	5	M101.F	3
103.TF	400x140	5	M101.F	3
103.DF	400x140	5	M102.F	3



103.T34



103.T40



103.TF34



103.TF



103.DF

**Grondwerkersspade**  
Louchet terrassière

art.nr.	mm	unit	ref.	kg.
120.T38	380x140	5	M101.2	2,25



**Spade Gent**  
Louchet Gand

art.nr.	mm	unit	ref.	kg.
111.T	350x160	5	M101.2	2,25



(111.T = 116.T16)





116.D14



116.D18 (Waasland)



130.TKHZ47



130.TKFZ47

**Spade met D-steel**

Louchet manche D

art.nr.	mm	unit	ref.	kg.
116.D13	400x130	5	M102.1	2,25
116.D14	400x140	5	M102.1	2,25
116.D15	400x150	5	M102.1	2,25
116.D16	350x160	5	M102.1	2,25
116.D18	300x180	5	M102.1	2,25

**Spade met T-steel**

Louchet manche T

art.nr.	mm	unit	ref.	kg.
116.T14	400x140	5	M101.2	2,25
116.T18	300x180	5	M101.2	2,25

**Kabelspade**

Louchet à cable

art.nr.	mm	unit	ref.	kg.
130.TKZ47	470x130	5	M101.11	2,5
130.TKHZ47	470x130	5	M101.11H	2,5
130.TKFZ47	470x130	5	-	3,2

**Boomspade hickory**

Louchet d'arboriculture hickory

art.nr.	mm	unit	ref.	kg.
113.TH	350x135	5	M101.4H	2,40

Boomspaden / Bêches d'arboriculture



Tuinspaden met open dul / Bêches à douille ouverte d'agriculture

**Spade Senlis met open dul**

Bêche Senlis à douille ouverte

art.nr.	mm	unit	ref.	kg.
106.T	280x170	5	M101.5	1,75

**Spade Namen**

Bêche Namur

art.nr.	mm	unit	ref.	kg.
109.T	280x170	5	M101.5	1,75
109.B	280x170	5	M103.1	1,75



D-steel  
Manche D  
art.nr. D

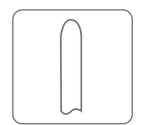

L-steel  
Manche L  
art.nr. L



T-steel  
Manche T  
art.nr. T

Overige / Divers

**Plantspade**

Bêche de plantation

art.nr.	mm	unit	ref.	kg.
114.T	245x90	5	-	2



**Aasspade**

Bêche de pêcheur

art.nr.	mm	unit	ref.	kg.
117.D	160x120	5	M102.1	2,25



**Sporkspade met gebogen steel**

Spork avec manche courbé

art.nr.	mm	unit	ref.	kg.
119.T	250x155	5	M101.13	1,5



**Spitwroeter verstelbaar - blauw**

Troll du jardin réglable - bleu

art.nr.	mm	unit	ref.	kg.
0100	980	5	-	1,70



**Tuinschop met gebogen T-steel en hoekijzeren voetsteuntjes**

Pelle jardin avec manche T courbé et repose-pieds soudés

art.nr.	mm	unit	ref.	kg.
703.1TZ	360x130	5	M101.14	1,8



(703.1Z = losse schop zonder steel / pelle sans manche)

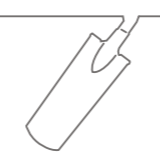

1 artikel . article



Spaden . Bêches

Opties / Options



**Hoekijzere voetsteun**

Repose-pied soudé

code	mm	unit	ref.	kg.
Z	40x20x20	2	-	0,05

vb	101.TZ	5	M101.1	2.25
----	--------	---	--------	------

Toepasbaar op art. nr - applicable aux n° d'art. 101/102/104

**Voetbeugel**

Etrier de pied

code	mm	unit	ref.	kg.
G	140x80x60	1	-	0,10

vb	103.TG40	5	M101.1	2.25
----	----------	---	--------	------

Toepasbaar op art. nr - applicable aux n° d'art. 101/102/103/104/111/113/116

**Extra korte steel 750 mm**

Manche ultra court 750 mm

code	mm	unit	ref.	kg.
K	750	1	-	

vb	103.TK40	5	M101.11	2.25
----	----------	---	---------	------

Toepasbaar op art. nr - applicable aux n° d'art. 103

**Voetsteuntje voor spaden**

Repose-pied pour bêches

art.nr.	mm	unit	ref.	kg.
M201	40	20	vrac	0,01
M201.B	40	10	blister 4pc	0,05

**Rivet voor spadesteel**

Goupille pour manche de bêche

art.nr.	mm	unit	ref.	kg.
M202	50	20	vrac	0,01
M202.B	50	10	blister 8pc	0,10



BLISTER

2

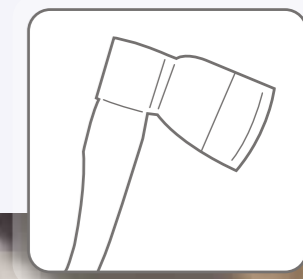



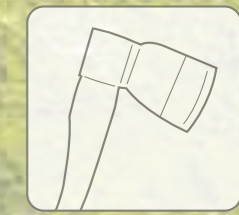

**Hakbijl groot met essen steel**

Hache à manche en frêne

art.nr.	mm	unit	ref.	kg.
201	900	1	M112.3	2,25

**Hakbijl met essen steel**

Hachette à manche en frêne

art.nr.	mm	unit	ref.	kg.
202	370	1	M112.5	1

**Snoeibijl met essen steel**

Hachette d'élargueur à manche en frêne

art.nr.	mm	unit	ref.	kg.
203	400	1	M112.6	1

**Handbijl met essen steel**

Hachette à manche en frêne

art.nr.	mm	unit	ref.	kg.
204	400	1	M112.7	0,8
212.1	400	1	M112.7	0,6

**Handbijl met glasvezelsteel + PVC**

Hachette à manche fibre de verre + PVC

art.nr.	mm	unit	ref.	kg.
FP204	400	1	-	0,6

**Bijl met essen steel**

Hache à manche en frêne

art.nr.	mm	unit	ref.	kg.
205	800	1	M112.4	1,6
212.2	800	1	M112.4	1,25

**Kliefbijl met essen steel**

Hache refendeuse à manche en frêne

art.nr.	mm	unit	ref.	kg.
213.20E	900	1	M112.9	2

**Bijl met glasvezelsteel + PVC**

Hache à manche en fibre de verre + PVC

art.nr.	mm	unit	ref.	kg.
FP205	920	1	FPM111	1,4

**Kliefhamer met essen steel**

Merlin à manche en frêne

art.nr.	mm	unit	ref.	kg.
206.E	900	1	M112.1	3

**Kliefhamer met volkern glasvezelsteel**

Merlin à manche en fibre de verre homogène

art.nr.	mm	unit	ref.	kg.
206.F	900	1	-	3

**Kliefhamer met hickory steel**

Merlin à manche en hickory

art.nr.	mm	unit	ref.	kg.
206.H	900	1	M112.2	3

**Kliefhamer met glasvezelsteel + PVC**

Merlin à manche fibre de verre + PVC

art.nr.	mm	unit	ref.	kg.
FP206	920	1	FPM111	3,5

**Ronde metalen spie**

Coin rond à emmancher

art.nr.	mm	unit	ref.	kg.
M203	ø 23x26	1	vrac	0,03
M203.1	ø 18x25	1	vrac	0,02
M203.B	2xM203 + 2xM203.1	10	blister 4pc	0,11
M204.B	4xM203.1	10	blister 4pc	0,08







**Houtwig**  
Coin à fendre

art.nr.	mm	unit	ref.	kg.
207	260x50	1	-	2



**Getorste houtwig**  
Coin à fendre tordue

art.nr.	mm	unit	ref.	kg.
207.1	260x60x60	1	-	2



**Hakmes Vlaanderen**  
Couperet Flandres

art.nr.	mm	unit	ref.	kg.
208	360	1	M113.1	0,75



**Hakmes Wallonië**  
Couperet Wallonie

art.nr.	mm	unit	ref.	kg.
209	400	1	-	0,8



**Snoeistek**  
Serpette

art.nr.	mm	unit	ref.	kg.
210	200x110	1	-	0,5
210.L	1420x110	1	M104.10	1



**Sparrensteker metalen steel**  
Rasette de sapin manche en acier

art.nr.	mm	unit	ref.	kg.
211	1420	1	-	7



Hakken en klein tuingereedschap

Houes et petits outils de jardin

3





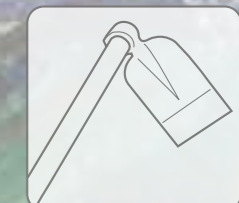

301.118FPL

**Biethak gesmeed**

Rasette à betteraves forgée

art.nr.	mm	unit	ref.	kg.
301.116	160x80	1	-	0,5
301.116L	160x80	5	M107.50	1
301.118	180x80	1	-	0,5
301.118L	180x80	5	M107.50	1
301.118FPL	180x80	1	FPM106.50	1,2
301.120	200x80	1	-	0,5
301.120L	200x80	5	M107.50	1



**Biethak**

Rasette à betteraves

art.nr.	mm	unit	ref.	kg.
301.216	160x80	1	-	0,5
301.216L	160x80	5	M106.50	1
301.218	180x80	1	-	0,5
301.218L	180x80	5	M106.50	1



**Halvemaanhak gesmeed**

Binette demi-lune forgée

art.nr.	mm	unit	ref.	kg.
302.10	100	1	-	0,25
302.10L	100	5	M106.50	0,5
302.12	120	1	-	0,25
302.12L	120	5	M106.50	0,5
302.14	140	1	-	0,25
302.14L	140	5	M106.50	0,5
302.16	160	1	-	0,25
302.16L	160	5	M106.50	0,5
302.18	180	1	-	0,25
302.18L	180	5	M106.50	0,5
302.20	200	1	-	0,25
302.20L	200	5	M106.50	0,5

**Schoffelhak gesmeed**

Ratissoire à tirer forgée

art.nr.	mm	unit	ref.	kg.
303.10	100	1	-	0,25
303.10L	100	5	M106.50	0,5
303.12	120	1	-	0,25
303.12L	120	5	M106.50	0,5
303.14	140	1	-	0,25
303.14L	140	5	M106.50	0,5
303.16	160	1	-	0,25
303.16L	160	5	M106.50	0,5
303.18	180	1	-	0,25
303.18L	180	5	M106.50	0,5
303.20	200	1	-	0,25
303.20L	200	5	M106.50	0,5



**Schoffel gesmeed**

Ratissoire forgée

art.nr.	mm	unit	ref.	kg.
304.10	100	1	-	0,25
304.10L	100	5	M106.50	0,5
304.12	120	1	-	0,25
304.12L	120	5	M106.50	0,5
304.14	140	1	-	0,25
304.14L	140	5	M106.50	0,5
304.16	160	1	-	0,25
304.16L	160	5	M106.50	0,5
304.18	180	1	-	0,25
304.18L	180	5	M106.50	0,5
304.20	200	1	-	0,25
304.20L	200	5	M106.50	0,5



**Tuinhak Shark**

Rasette de jardin Shark

art.nr.	mm	unit	ref.	kg.
301.314	140	1	-	0,35
301.314L	140	5	M106.50	0,9

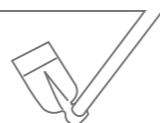



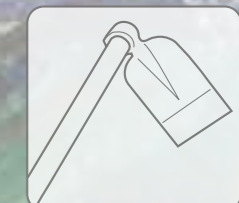

**Volle maan schoffel met essen steel**  
Ratissoire à pousser pleine lune avec manche en frêne

art.nr.	mm	unit	ref.	kg.
304.214L	140	1	-	1



**Spork schoffel met essen steel**  
Binette Spork avec manche en frêne

art.nr.	mm	unit	ref.	kg.
304.310L	100	1	-	1,12



**Hak met roestvrij blad**  
Rasette lame inox

art.nr.	mm	unit	ref.	kg.
305.16	160	1	-	0,25
305.16L	160	5	M106.50	0,5



**Beugelhak**  
Ratissoire 2 branches

art.nr.	mm	unit	ref.	kg.
306.16	160	1	-	0,25
306.16L	160	5	M106.50	0,5
306.16FPL	160	1	FPM106.50	0,85

306.16FPL



**Hak schaafmodel**  
Grattoir lame acier

art.nr.	mm	unit	ref.	kg.
307.16	160	1	-	0,25
307.16L	160	5	M106.50	0,5



**Hak Namen**  
Rasette Namur

art.nr.	mm	unit	ref.	kg.
308.14	220x140	1	-	1
308.14L	220x140	5	M108.45	1,5

**Ophooghak**  
Houe

art.nr.	mm	unit	ref.	kg.
308.16	220x160	1	-	1
308.16L	220x160	5	M108.45	1,5

**Hak met drietand voor lange steel gegalvaniseerd**  
Rasette 3 dents manche galvanisé

art.nr.	mm	unit	ref.	kg.
309	70x220	1	-	0,25
309.L	70x220	5	M106.50	0,5

**Open hak met korte steel**  
Rasette à manche court

art.nr.	mm	unit	ref.	kg.
310	110x400	1	M113.310	0,5

**Halvemaanhak met korte steel**  
Rasette demi-lune à manche court

art.nr.	mm	unit	ref.	kg.
311	125x380	1	M113.311	0,5

**Hak drietand met korte steel**  
Rasette trois dents à manche court

art.nr.	mm	unit	ref.	kg.
312	65x190x280	10	-	0,2

**Cultivator met korte steel**  
Cultivateur à manche court

art.nr.	mm	unit	ref.	kg.
313	320	10	-	0,33

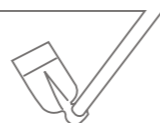



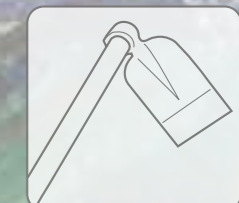

Hakken en klein tuingereedschap  
Houes et petits outils de jardin

Hakken en klein tuingereedschap  
Houes et petits outils de jardin



**Hark met korte steel**  
Râteau à manche court

art.nr.	mm	unit	ref.	kg.
314	110x280	10	-	0,25



**Bladrif met korte steel**  
Balai à feuillage à manche court

art.nr.	mm	unit	ref.	kg.
314.1	340	10	-	0,25



**Plantschopje**  
Transplantoir

art.nr.	mm	unit	ref.	kg.
315.1	320	12	-	0,25



**Plantschopje uit gestampt staal**  
Transplantoir en acier estampé

art.nr.	mm	unit	ref.	kg.
315.2	300	12	-	0,25



**Plantschopje gesmeed**  
Transplantoir forgé

art.nr.	mm	unit	ref.	kg.
315.3	300	1	-	0,25



**Voegenreiniger**  
Couteau pour nettoyer les joints

art.nr.	mm	unit	ref.	kg.
328.2	270	10	-	0,35

**Voegenborstel met lange steel**  
Brosse à manche long pour nettoyer les joints

art.nr.	mm	unit	ref.	kg.
328.3	100x1500	5	-	0,3



**Planttouw**  
Cordeau de jardin

art.nr.	m	unit	ref.	kg.
316	10	1	-	0,2



**Planter met korte steel**  
Plantoir crosse bois à manche court

art.nr.	mm	unit	ref.	kg.
317.K	300	1	-	0,25



**Planter met lange T steel**  
Plantoir crosse bois à manche T long

art.nr.	mm	unit	ref.	kg.
317.L	.	1	M113.30	0,25



**Knollenplanter**  
Plantoir à bulbes

art.nr.	mm	unit	ref.	kg.
318	230x80	10	-	0,36



**Bloembolplanter Ø 5-6 cm**  
Plantoir à bulbes à fleurs Ø 5-6 cm

art.nr.	mm	unit	ref.	kg.
319.06	1150	1	.	1,2

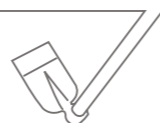



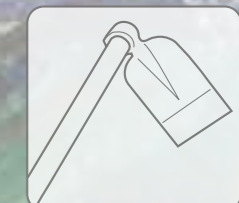

**Aardappelplanter Ø 7,5-12,5 cm / H15cm**  
Plantoir de pommes de terre Ø 7,5-12,5 cm / H15cm

art.nr.	mm	unit	ref.	kg.
319	1150	1	-	1



**Potplanter Ø 11-17 cm / H13cm**  
Plantoir de pot Ø 11-17 cm / H13cm

art.nr.	mm	unit	ref.	kg.
319.15	1150	1	.	2



**Potplanter Ø 15-19 cm / H17,5cm**  
Plantoir de pot Ø 15-19 cm / H17,5cm

art.nr.	mm	unit	ref.	kg.
319.19	1150	1	.	3



**Preiplanter met 5 tanden**  
Plantoir pour poireau avec 5 dents

art.nr.	mm	unit	ref.	kg.
320	560x1000	1	-	3



**Handploegje**  
Butteur

art.nr.	mm	unit	ref.	kg.
321	200	1	-	0,25
321.L	1650	5	M107.50	0,5



**Tuinrol metaal Ø 30cm**  
Rouleau de jardin en métal Ø 30cm

art.nr.	mm	unit	ref.	kg.
322.1	450	1	32 dm <sup>3</sup>	9,5

**Koolmes**  
Couteau à choux

art.nr.	mm	unit	ref.	kg.
325	440	1	-	1



**Machette**  
Machette

art.nr.	mm	unit	ref.	kg.
326	570	1	-	0,5



**Aspergesteker gesmeed**  
Coupe-asperges forgé

art.nr.	mm	unit	ref.	kg.
327	430x30	1	-	0,5



**Sikkel gesmeed**  
Faucille forgée

art.nr.	mm	unit	ref.	kg.
329	360x240	1	-	0,25



**Handpikje gesmeed**  
Fauchette forgée

art.nr.	mm	unit	ref.	kg.
330	320x340	1	-	0,32



**Pik**  
Sape

art.nr.	mm	unit	ref.	kg.
331	550	1	-	0,25

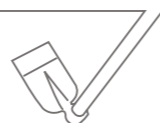



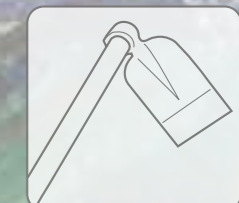

**Pikwerf**  
Manche de poix

art.nr.	mm	unit	ref.	kg.
331.M	400	1	-	0,5



**Pik met steel**  
Sape avec manche

art.nr.	mm	unit	ref.	kg.
331.K	550x400	1	-	2



**Ring voor pik**  
Anneau pour manche de poix

art.nr.	mm	unit	ref.	kg.
331.R	40x50x60	1	-	0,1



**Zeis diamantstaal**  
Faux en acier diamant

art.nr.	mm	unit	ref.	kg.
332.45	450	1	-	0,7



**Zeis diamantstaal**  
Faux en acier diamant

art.nr.	mm	unit	ref.	kg.
332.65	650	1	-	0,8

332.M1HVY

332.M1HV



**Zeissteel recht**  
Manche pour faux droit

art.nr.	mm	unit	ref.	kg.
332.M1	1650	5	-	2

**Zeissteel gebogen**  
Manche pour faux courbé

art.nr.	mm	unit	ref.	kg.
332.M2	1500	5	-	2



**Ring voor zeissteel**  
Anneau pour manche pour faux

art.nr.	mm	unit	ref.	kg.
332.R	40x50x60	1	-	0,2



**Wetsteen**  
Pierre à aiguiser

art.nr.	mm	unit	ref.	kg.
333	225	10	-	0,16



**Smartweeder**  
Smartweeder

art.nr.	mm	unit	ref.	kg.
336.1	940	5	M113.336	0,4

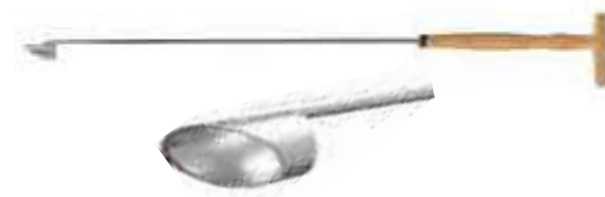

**Spiraal paardebloemwieder**  
Arrache racines spirale

art.nr.	mm	unit	ref.	kg.
336.2	970	1	.	0,6



**Compostwoeler alu**  
Aérateur à compost alu

art.nr.	mm	unit	ref.	kg.
337	900	1	.	0,4

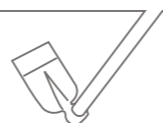





4

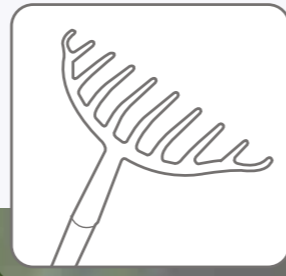

### Cultivator verzinkt met 3 tanden

Cultivateur zingué avec 3 dents

art.nr.	mm	unit	ref.	kg.
401	120	1	-	0,25
401.L	120	5	M106.50	0,5
401.FPL	120	1	FPM106.50	0,85

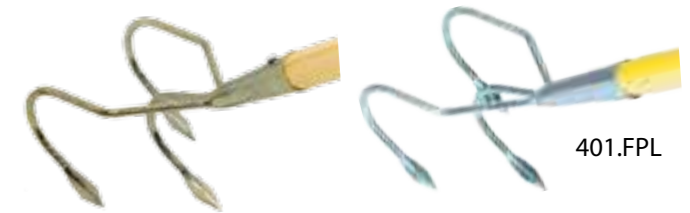

401.FPL

### Tuinhark verzinkt

Râteau zingué

art.nr.	mm	unit	ref.	kg.
402.06	140	1	-	0,25
402.06L	140	5	M106.50	1
402.08	190	1	-	0,25
402.08L	190	5	M106.50	1
402.10	240	1	-	0,25
402.10L	240	5	M106.50	1
402.12	300	1	-	0,25
402.12L	300	5	M106.50	1
402.12FPL	300	1	FPM106.50	1
402.14	350	1	-	0,25
402.14L	350	5	M106.50	1
402.16	400	1	-	0,25
402.16L	400	5	M106.50	1



402.12FPL

### Rozenhark met 10 tanden

Râteau à rosiers avec 10 dents

art.nr.	mm	unit	ref.	kg.
402.R	250	1	-	0,2
402.RL	250	5	M106.50	0,5

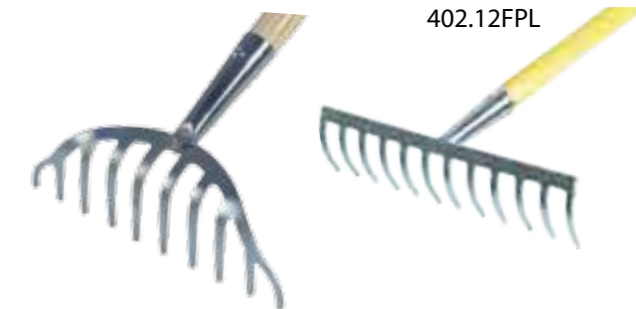

### Hark met gesmede tanden

Râteau forgé

art.nr.	mm	unit	ref.	kg.
403.12	375	1	-	1,2
403.12L	375	5	M107.50	1,4
403.14	440	1	-	1,4
403.14L	440	5	M107.50	1,6





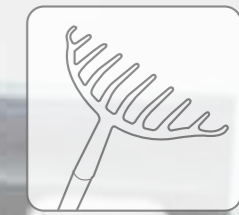

**Hark met ronde tanden**  
Râteau avec dents rondes

art.nr.	mm	unit	ref.	kg.
403.108	350	1	-	0,7
403.108L	350	5	M107.50	1,3
403.110	310	1	-	0,8
403.110L	310	5	M107.50	1,3
403.112	375	1	-	0,9
403.112L	375	5	M107.50	1,4
403.114	440	1	-	1,1
403.114L	440	5	M107.50	1,6

**Inzaaihark alu 19 tanden**  
Râteau à semis en alu 19 dents

art.nr.	mm	unit	ref.	kg.
405	600	1	-	0,6

**Inzaaihark PVC 16 tanden**  
Râteau à semis PVC 16 dents

art.nr.	mm	unit	ref.	kg.
405.01	640	1	-	0,4



**Gazonafboorder halve maan**  
Coupe bordures demi-lune

art.nr.	mm	unit	ref.	kg.
404.1T	210x1100	5	M101.8	1



**Gazonafboorder rechthoekig**  
Coupe bordures rectangulaire

art.nr.	mm	unit	ref.	kg.
404.2T	200x1100	5	M101.8	1



**Gazonafboorder met inox wiel**  
Coupe bordures avec roue coupante en inox

art.nr.	mm	unit	ref.	kg.
404.3D	220x1150	1	M102.6	3,5

**Hooihark schuin PVC 16 tanden**  
Râteau à foin incline PVC 16 dents

art.nr.	mm	unit	ref.	kg.
405.02	640	1	-	0,5

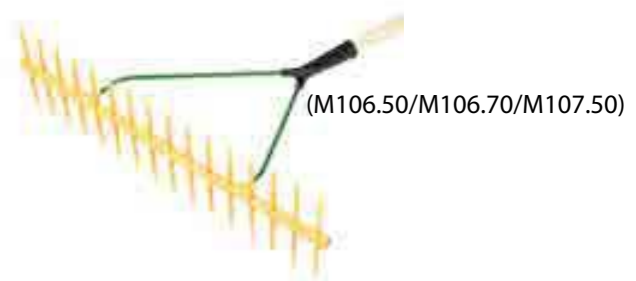

**Verticuteerhark met 32 verzinkte tanden**  
Scarificateur avec 32 dents zinguées

art.nr.	mm	unit	ref.	kg.
406.1	400	1	-	1
406.1L	400	1	M107.50	1,3



**Gazonhark verzinkt**  
Râteau à gazon zingué

art.nr.	mm	unit	ref.	kg.
405.060	600	1	-	0,9
405.060L	600	1	M107.50	1,1
405.080	800	1	-	1,2
405.080L	800	1	M107.50	1,4
405.100	1000	1	-	1,7
405.100L	1000	1	M107.50	1,9

**Bladrijf professioneel met 22 tanden**  
Balai à feuillage professionnel avec 22 dents

art.nr.	mm	unit	ref.	kg.
407.1	450	1	-	0,5
407.1L	450	5	M106.50	1





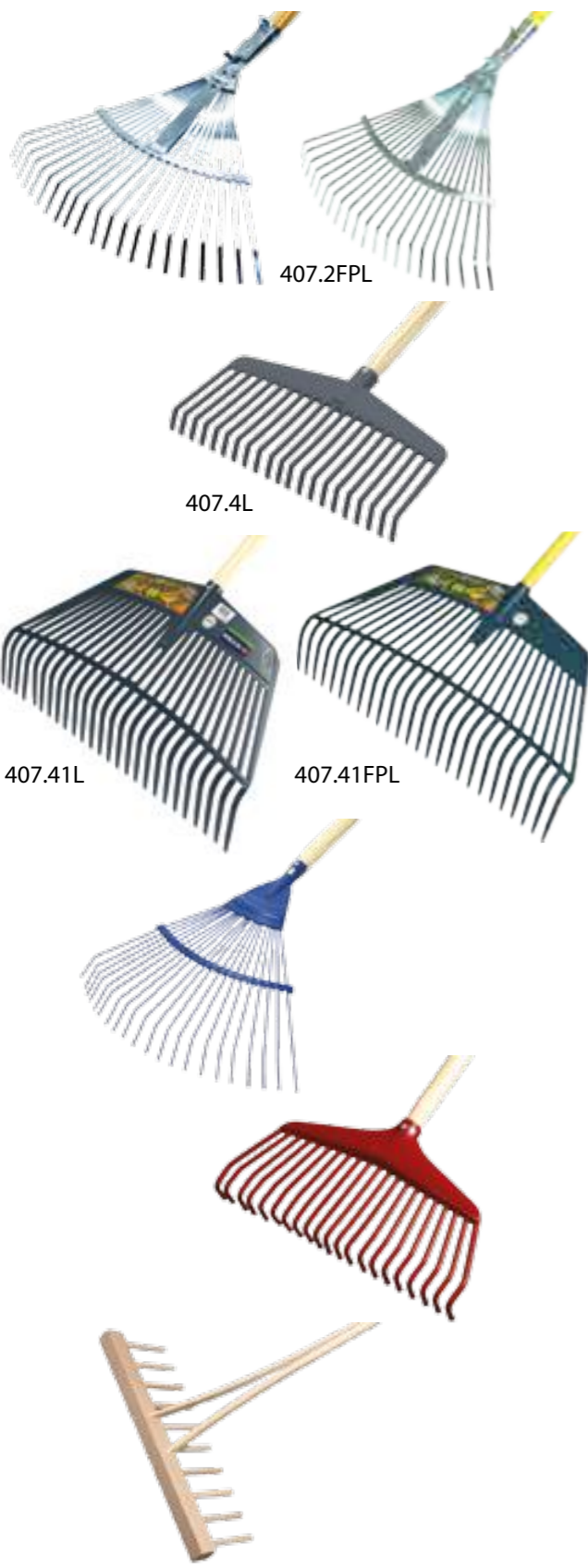
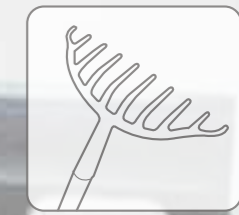

**Bladrijf verstelbaar met 21 tanden**  
Balai à feuillage réglable avec 21 dents

art.nr.	mm	unit	ref.	kg.
407.2	380 - 530	1	-	0,5
407.2L	380 - 530	5	M106.50	1
407.2FPL	380 - 530	1	FPM106.50	1,25

**Bladrijf polyamide**  
Balai à feuillage polyamide

art.nr.	mm	unit	ref.	kg.
407.4L	380	5	M106.50	0,7
407.41L	600	5	M106.50	0,8
407.41FPL	600	1	FPM106.50	1

**Bladrijf met 21 ronde tanden**  
Balai à feuillage avec 21 dents rondes

art.nr.	mm	unit	ref.	kg.
407.5	420	5	-	0,60
407.5L	420	5	M106.50	1,10

**Bladrijf kunststof 'Fiskars' met 21 tanden**  
Balai à feuillage en plastique 'Fiskars' avec 21 dents

art.nr.	mm	unit	ref.	kg.
407.7L	400	5	M106.50	0,6

**Houten hooihark met 10 tanden**  
Râteau à foin en bois avec 10 dents

art.nr.	mm	unit	ref.	kg.
408.L	600x1800	1	-	1,5



**Grijptang voor afval**  
Pince à papier / déchets

art.nr.	mm	unit	ref.	kg.
410	950	1	-	1,5

**Bladopraper alu/galva**  
Pince feuilles alu/galva (Ramassetou)

art.nr.	mm	unit	ref.	kg.
414.2	900	1	.	0,95

**Vuilniszakdrager met versterking**  
Porte sac poubelle avec renfort

art.nr.	mm	unit	ref.	kg.
415	400	1	.	1





## Snoeigereedschap . Outils de taille



5

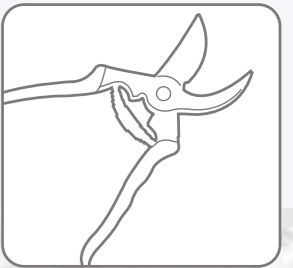





**Snoeischaar**  
Sécateur

art.nr.	mm	unit	mm	kg.
501.1	220	10	60	0,25



**Snoeischaar gesmeed**  
Sécateur forgé

art.nr.	mm	unit	mm	kg.
501.2	220	10	60	0,27



**Aambeeldsnoeischaar Rolling Cut**  
Sécateur à enclume Rolling Cut

art.nr.	mm	unit	mm	kg.
501.3	200	10	40	0,28



**Vervangset voor 501.3**  
Set de réchange pour 501.3

art.nr.	mm	unit	mm	kg.
501.31	-	1	blister	0,1

(linkse schroefdraad/filetage à gauche)



**Grasschaar verstelbaar**  
Cisaille à gazon orientable

art.nr.	mm	unit	mm	kg.
502.1	340	10	140	0,42

**Grasschaar met 2 beweegbare messen**  
Cisaille à gazon avec 2 lames mobiles

art.nr.	mm	unit	mm	kg.
502.2	340	10	120	0,38



**Grasschaar met lange alu grepen verticaal**  
Cisaille à gazon à manches longs verticale en alu

art.nr.	mm	unit	mm	kg.
502.4	640-1050	1	170	0,84



**Grasschaar lange alu grepen horizontaal verstelbaar**  
Cisaille à gazon à manches longs horizontal en alu

art.nr.	mm	unit	mm	kg.
502.6	620-1020	1	170	1,16



**Buxussnoeischaar**  
Cisaille pour buxus

art.nr.	mm	unit	mm	kg.
502.5	320	10	155	0,2



**Haagschaar met gegolfde messen**  
Cisailles à haie lames ondulées

art.nr.	mm	unit	mm	kg.
503.6	600	1	200	1,1

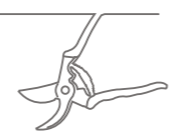



**Prof. haagschaar met rechte messen**

Cisaille prof. à haie lames droites

art.nr.	mm	unit	mm	kg.
503.2	600	1	200	1



**Prof. haagschaar met gegolfde messen**

Cisaille prof. à haie lames ondulées

art.nr.	mm	unit	mm	kg.
503.3	600	1	220	1



Ø 40 mm

**Takkenschaar**

Ebranchoir

art.nr.	mm	unit	mm	kg.
504.1	700	1	80	1

520.16 = vervangset / set de réchange

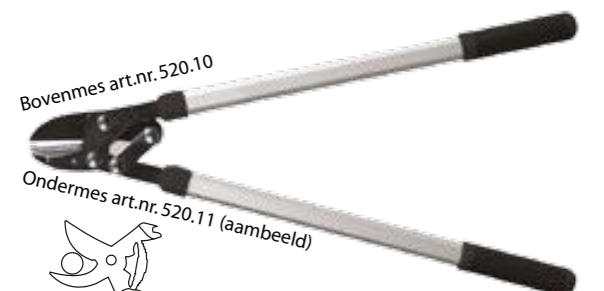

Bovenmes art.nr. 520.10

Ondermes art.nr. 520.11 (aambeeld)

Ø 55 mm

**Takkenschaar met hefboomwerking**

Ebranchoir à enclume

art.nr.	mm	unit	mm	kg.
504.2	750	1	80	2



Bovenmes art.nr. 520.15

Ø 45 mm

**Takkenschaar met hefboomwerking en ergo handgreep**

Ebranchoir à enclume avec poignée ergo

art.nr.	mm	unit	mm	kg.
504.3	700	1	60	2

**Snoeizaag met korte steel en PVC handvat**

Scie d'élagage avec manche court à main PVC

art.nr.	mm	unit	mm	kg.
506.1	450	10	280	0,5

**Boomzaag**

Scie à bûches

art.nr.	mm	unit	ref. zaagblad (p.41)	kg.
507.1	530	12	520.4	0,5
507.2	760	10	520.5	0,5



**Oculeermes professioneel (blister)**

Greffoir professionnel

art.nr.	mm	unit	mm	kg.
508.1	160	1	65	0,04



**Oculeermes / zakmes (blister)**

Greffoir

art.nr.	mm	unit	mm	kg.
508.2	170	1	70	0,05



**Oculeermes linkshandig (vrac)**

Greffoir gaucher

art.nr.	mm	unit	mm	kg.
508.4	170	1	70	0,05



**Snoeimes (blister)**

Serpette

art.nr.	mm	unit	mm	kg.
508.5	170	1	70	0,05







Snoeischaren Felco / Sécateurs Felco



**Felco 2**

art.nr.	mm	unit	mm	kg.
501.F2	215	1	55	0,24



**Felco 4**

art.nr.	mm	unit	mm	kg.
501.F4	210	1	55	0,22



**Felco 5**

art.nr.	mm	unit	mm	kg.
501.F5	225	1	60	0,31



**Felco 6 (compact)**

art.nr.	mm	unit	mm	kg.
501.F6	195	1	55	0,21



**Felco 7**

art.nr.	mm	unit	mm	kg.
501.F7	210	1	55	0,29

**Felco 8**

art.nr.	mm	unit	mm	kg.
501.F8	210	1	55	0,245



**Felco 9**

art.nr.	mm	unit	mm	kg.
501.F9	210	1	55	0,245



**Felco 10 (linkshandig / pour gauchers)**

art.nr.	mm	unit	mm	kg.
501.F10	210	1	55	0,29



**Felco 11**

art.nr.	mm	unit	mm	kg.
501.F11	210	1	55	0,24



**Felco 12**

art.nr.	mm	unit	mm	kg.
501.F12	200	1	50	0,26



**Felco 13**

art.nr.	mm	unit	mm	kg.
501.F13	270	1	55	0,31

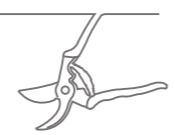



**Felco 31**

art.nr.	mm	unit	mm	kg.
501.F31	210	1	50	0,22



**Felco 100 met 2 regelbare snijopeningen**  
Felco 100 avec 2 positions d'ouverture

art.nr.	mm	unit	mm	kg.
501.F100	210	1	55	0,22



**Felco 160S - compact**

art.nr.	mm	unit	mm	kg.
501F.160S	200	1	45	0,16



**Felco 160L - ergo**

art.nr.	mm	unit	mm	kg.
501F.160L	220	1	50	0,18

Draad- en kabelscharen Felco / Cisailles à fils et câbles Felco **FELCO**



**Felco CP**

art.nr.	mm	unit	mm	kg.
501.FCP	205	1	40	0,3

**Felco C7**

art.nr.	mm	unit	mm	kg.
501.FC7	190	1	15	0,27



Takkenscharen Felco / Ebrancheurs Felco **FELCO**

**Felco 210A - met aluminium steel**

art.nr.	mm	unit	mm	kg.
501.F210A40	400	1	70	0,675
501.F210A50	500	1	70	0,735
501.F210A60	600	1	70	0,795

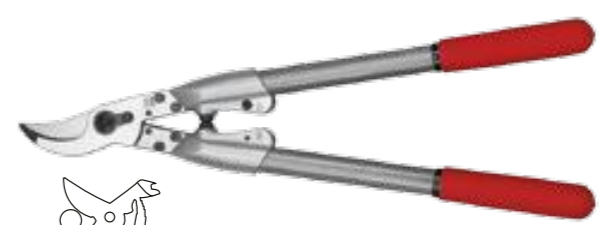

**Felco 210C - met carbon steel**

art.nr.	mm	unit	mm	kg.
501.F210C50	500	1	70	0,68
501.F210C60	600	1	70	0,71



**Felco 22**

art.nr.	mm	unit	mm	kg.
501.F22	840	1	65	1,98

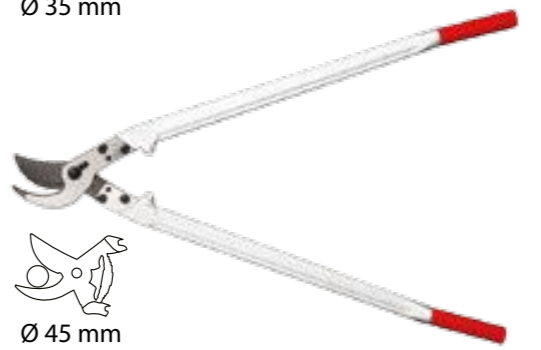

Snoeizagen Felco / Sciés d'élagage Felco **FELCO**

**Felco 600**

art.nr.	mm	unit	mm	kg.
501.F600	350	1	160	0,16

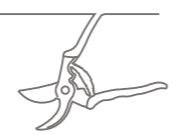





**Felco 611**

art.nr.	mm	unit	mm	kg.
501.F611	520	1	330	0,37

**Felco 621**

art.nr.	mm	unit	mm	kg.
501.F621	430	1	240	0,30

Accessoires Felco



**Felco 902 slijpsteen**

Felco 902 pierre à affûter

art.nr.	mm	unit	mm	kg.
501.F902	100	1	-	0,04

**Felco 910 etui met sleuf en clip**

Felco 910 étui avec passant et pince

art.nr.	mm	unit	mm	kg.
501.F910	240	1	-	0,13

**Felco 980 spray - Felco 990 vet**

Felco 980 spray - Felco 990 graisse

art.nr.	ml - gr	unit	mm	kg.
501.F980	56 ml	1	-	0,082
501.F990	30 gr	1	-	0,050

Zie prijslijst voor meer accessoires. Pour plus d'accessoires, veuillez consulter notre tarif.

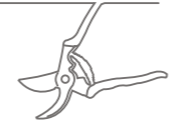

Green Technology



**Okatsune 301 citrusschaar**

Okatsune 301 sécateur pour agrumes

art.nr.	mm	unit	mm	kg.
505.1	160	1	25	0,11

**Okatsune 304 dunschaar**

Okatsune 304 cisaille d'élagage

art.nr.	mm	unit	mm	kg.
505.2	190	1	45	0,11

**Okatsune 307 dunschaar**

Okatsune 307 cisaille d'élagage

art.nr.	mm	unit	mm	kg.
505.3	180	1	35	0,12

**Okatsune 103 snoeischaar**

Okatsune 103 sécateur

art.nr.	mm	unit	mm	kg.
505.103	220	1	60	0,24

**Buxusschaar Saboten 1550**

Cisaille à buxus Saboten 1550

art.nr.	mm	unit	mm	kg.
505.4	520	1	150	0,58

(buxus & klein struikgewas)





**Graskantschaar prof.**  
Cisaille à gazon prof.

art.nr.	mm	unit	mm	kg.
505.5	350	1	120	0,38



**Haagschaar prof. met lange benen**  
Cisaille à haie à poignées longues prof.

art.nr.	mm	unit	mm	kg.
505.6	730	1	200	1,02



**Presenteersnoeischaar**  
Sécateur avec dispositif

art.nr.	mm	unit	mm	kg.
505.7	380	1	60	0,36



**Snoeischaar op lange steel**  
Sécateur à poignée longue

art.nr.	mm	unit	mm	kg.
505.8	650	1	60	0,384



**Snoeischaar / zaag met telescopische steel**  
Cisaille / scie télescopique

art.nr.	mm	unit	mm	kg.
505.9	2000 - 3000	1	60	0,93



**Onkruidwieder Saboten**  
Sécateur à désherber Saboten

art.nr.	mm	unit	mm	kg.
505.10	180	1	20	0,1



Snoeizagen Silky / Scies Silky



**Silky super accel 210x7,5 vouwzaag**  
Silky super accel 210x7,5 scie pliable

art.nr.	mm	unit	mm	kg.
509.1	210x7,5	1	-	0,22
509.2	blade	1	210	0,05



**Silky F180x8 vouwzaag**  
Silky F180x8 scie pliable

art.nr.	mm	unit	mm	kg.
509.3	180x8	1	-	0,17
509.4	blade	1	180	0,04



**Silky Pocketboy zwart 170x10 vouwzaag**  
Silky Pocketboy noir 170x10 scie pliable

art.nr.	mm	unit	mm	kg.
509.7	170x10	1	-	0,28
509.8	blade	1	170	0,04



**Silky Gomtaro holsterzaag**  
Silky Gomtaro scie avec étui

art.nr.	mm	unit	mm	kg.
509.9	270x8	1	-	0,36
509.10	blade	1	270	0,04
509.23	300x8	1	-	0,38
509.22	blade	1	300	0,04







**Silky Zubat 270x7,5 holsterzaag**  
Silky Zubat 270x7,5 scie avec étui

art.nr.	mm	unit	mm	kg.
509.31	440	1	-	0,22
509.32	blade	1	270	0,04



**Silky Zubat 3900 stokzaag 2 parts**  
Silky Zubat 3900 perche 2 parts

art.nr.	mm	unit	mm	kg.
509.11	2350	1	-	1,72
509.27	blade	1	330	0,14



**Silky Hayauchi 4900x6,5 stokzaag 3 parts**  
Silky Hayauchi 4900x6,5 perche 3 parts

art.nr.	mm	unit	mm	kg.
509.13	2350	1	-	2,65
509.24	blade	1	390	0,36



**Silky Hayate 5000 stokzaag 3 parts**  
Silky Hayate 5000 perche 3 parts

art.nr.	mm	unit	mm	kg.
509.34	2400	1	-	3,3
509.26	blade	1	420	0,73



**Zaagblok Silky met klem**  
Silky chevalet de scieur de bois

art.nr.	mm	unit	mm	kg.
509.91	700x1000	1	-	9,5

**Silky holstercase**  
Silky étui

art.nr.	mm	unit	ref.	kg.
509.240W	240	1	vrac	0,52
509.200V	220	1	vrac	0,4



509.240W  
dubbel / double



509.200V  
single

Onderdelen en herstellingen / Pièces détachées et réparations

**Mes voor Felco 2 en 4**  
Lame pour Felco 2 et 4

art.nr.	mm	unit	ref.	kg.
520.1	80	1	vrac	0,2



**Verchoomde veer voor snoeiscaar**  
Ressort chromé pour sécateur

art.nr.	mm	unit	ref.	kg.
520.2	60	1	vrac	0,1



**Veer voor grasschaar**  
Ressort pour cisaille à gazon

art.nr.	mm	unit	ref.	kg.
520.3	80	1	vrac	0,1
520.3B	80	10	blistre 2pc	0,4



**Zaagblad van gehard staal**  
Lame de rechange d'acier trempé

art.nr.	mm	unit	ref.	kg.
520.4	530	10	vrac	0,2
520.5	760	10	vrac	0,2

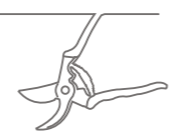





## Vorken . Fourches



Stift  
Soie  
code S

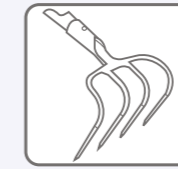

Dul  
Douille  
code D

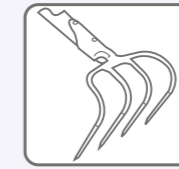

Lipdul  
Douille à patte  
code V

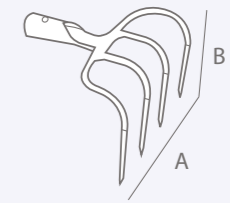

D-steel  
Manche D  
art.nr. D

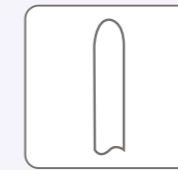

L-steel  
Manche L  
art.nr. L

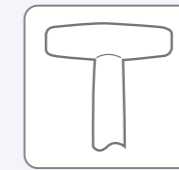

T-steel  
Manche T  
art.nr. T

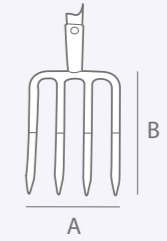

A x B x tot. lengte/long. totale

6







Stift  
Soie  
code S



Dul  
Douille  
code D



Lipdul  
Douille à patte  
code V

**Tuinkrauwel 4 tanden**

Petit croc de jardin 4 dents

art.nr.	mm	unit	code	ref.	kg.
601.L	130x125x1450	5	S	M109.230	2

**Mesthaak 4 tanden**

Croc à fumier 4 dents

art.nr.	mm	unit	code	ref.	kg.
602	220x200	1	V	-	1
602.L	1450	5	V	M104.3	2

**Mesthaak 4 tanden**

Croc à fumier 4 dents

art.nr.	mm	unit	code	ref.	kg.
603.L	210x200x1450	5	S	M109.230	2

**Spithaak 4 tanden**

Croc à bêcher 4 dents

art.nr.	mm	unit	code	ref.	kg.
604	190x175	1	D	-	1
604.L	1450	5	D	M104.10	2

**Spitvork**

Fourche à bêcher

art.nr.	mm	unit	code	ref.	kg.
605	180x275	1	D	-	1
605.D	1140	5	S	M102.4	2
605.T	1140	5	S	M101.7	2
605.B	1140	1	D	M103.2	2
605.FPT	1200	1	D	FPM101	2

**Spitvork professioneel met hoekijzere voetsteuntjes**

Fourche à bêcher professionnel avec repose-pieds soudés

art.nr.	mm	unit	code	ref.	kg.
605.TP	170x275x1150	1	S	M101.7	2,5

**Hooivork 2 tanden 160 x 300 mm**

Fourche à foin 2 dents 160 x 300 mm

art.nr.	mm	unit	code	ref.	kg.
606.L3	1650	5	S	M109.230	2
606.L5	1800	5	S	M109.250	2
606.L6	1950	5	S	M109.265	2

**Balenvork 2 tanden**

Fourche à ballot 2 dents

art.nr.	mm	unit	code	ref.	kg.
607.L	170x250x1600	5	S	M109.230	2

**Vork 3 tanden**

Fourche 3 dents

art.nr.	mm	unit	code	ref.	kg.
608	230x325	1	D	-	0,59
608.L	1650	5	S	M109.130	1,5

**Mestvork 4 tanden**

Fourche à fumier 4 dents

art.nr.	mm	unit	code	ref.	kg.
609	230x330	1	V	-	1
609.D	1180	5	S	M102.4	2
609.L	1650	5	S	M109.130	1,5
609.T	1180	5	S	M101.7	2
609.1FPL	1650	1	V	FPM104	2

**Aardappelriek 4 tanden**

Fourche à pommes de terre 4 dents

art.nr.	mm	unit	code	ref.	kg.
610	210x310	1	D	-	0,8
610.T	1280	5	D	M101.6	1,5
610.L	1650	5	D	M104.1	1,8

**Mestvork 5 tanden**

Fourche à fumier 5 dents

art.nr.	mm	unit	code	ref.	kg.
611	250x320	1	V	-	1
611.T	1270	5	V	M101.6	1,5
611.L	1650	5	V	M104.1	1,8
611.FPL	1650	1	V	FPM104	2

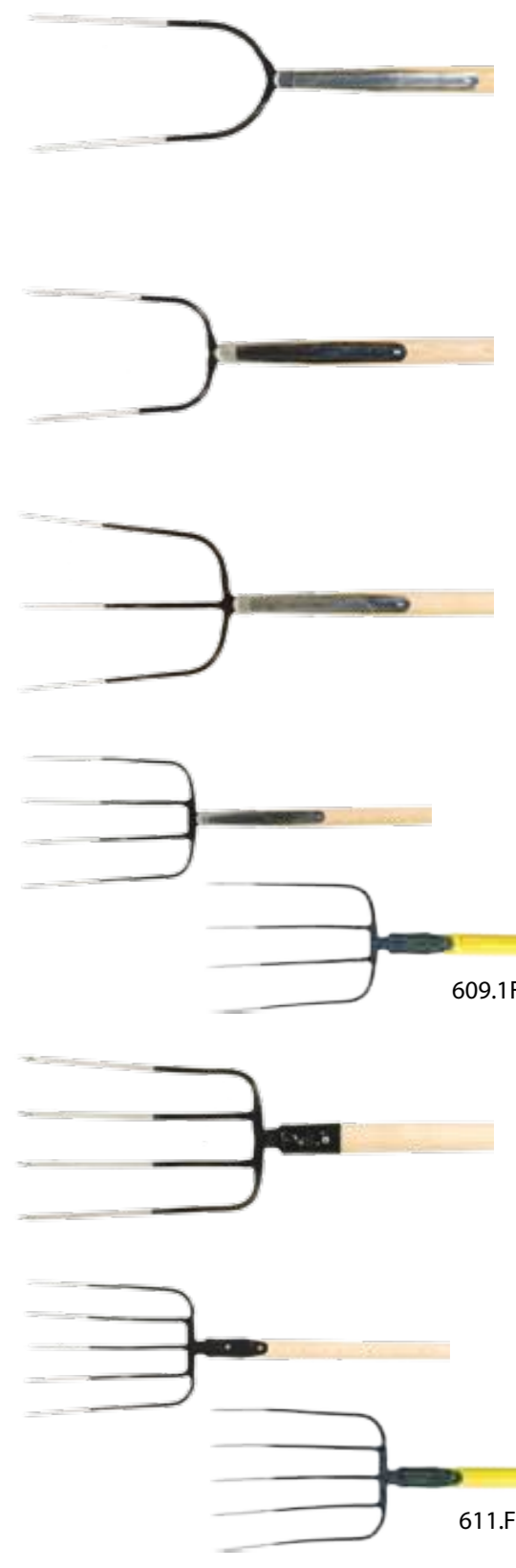

D-steel  
Manche D  
art.nr. D

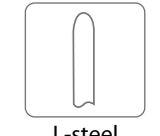

L-steel  
Manche L  
art.nr. L

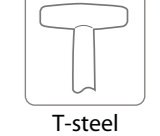

T-steel  
Manche T  
art.nr. T

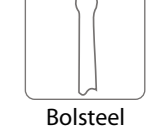

Bolsteel  
Manche Boule  
art.nr. B

609.1FPL

611.FPL

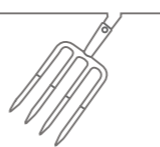



**Mestvork 5 tanden**  
Fourche à fumier 5 dents

art.nr.	mm	unit	code	ref.	kg.
612.L	250x320x1650	5	S	M109.130	2



**Maisvork 6 tanden**  
Fourche à maïs 6 dents

art.nr.	mm	unit	code	ref.	kg.
613	310x390	1	V	-	2
613.D	1310	5	V	M102.2	3
613.L	1680	5	V	M104.1	3



**Bietenfork 6 tanden**  
Fourche à betteraves 6 dents

art.nr.	mm	unit	code	ref.	kg.
614	300x370	1	V	-	2
614.D	1300	5	V	M102.2	3
614.L	1680	5	V	M104.1	3



**Steenfork 9 tanden**  
Fourche à cailloux 9 dents

art.nr.	mm	unit	code	ref.	kg.
615	250x350	1	V	-	2
615.D	1300	5	V	M102.2	3
615.L	1640	5	V	M104.1	2,5



**Aardappelvork 9 tanden**  
Fourche de pommes de terre 9 dents

art.nr.	mm	unit	code	ref.	kg.
616	270x385	1	V	-	2
616.D	1340	5	V	M102.2	3
616.L	1700	5	V	M104.1	2,7



**Paardenmestvork in kunststof met steel**  
Fourche à fumier de cheval en plastique avec manche

art.nr.	mm	unit	code	ref.	kg.
617.L	400x310x1700	1	-	-	1

**Paardenmestvork metaal 20 tanden**  
Fourche à fumier pour chevaux en métal 20 dents

art.nr.	mm	unit	code	ref.	kg.
617.1	380x275	1	-	-	1,25
617.1L	1675	1	-	M107.40	2,0



**Bio tuinvork met houten stelen**  
Bio-fourche avec manches en bois

art.nr.	mm	unit	code	ref.	kg.
618.03L	310x360	1	-	M104.1	3,6
618.05L	530x360	1	-	M104.1	4,4



**Bio tuinvork galva 5 rechte tanden**  
Bio-fourche galvanisé 5 dents droits

art.nr.	mm	unit	code	ref.	kg.
619.05	500x105	1	-	-	4



Stift  
Soie  
code S



Dul  
Douille  
code D



Lipdul  
Douille à patte  
code V

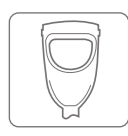

D-steel  
Manche D  
art.nr. D

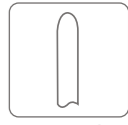

L-steel  
Manche L  
art.nr. L

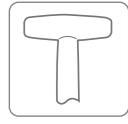

T-steel  
Manche T  
art.nr. T

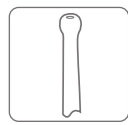

Bolsteel  
Manche Boule  
art.nr. B

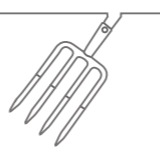





# Schoppen . Pelles

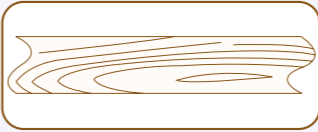

steel Es  
manche Frêne  
code E

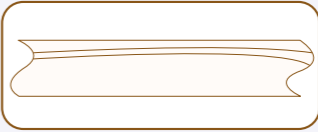

steel Beuk  
manche Hêtre  
code B



D-steel  
manche D  
art.nr. D

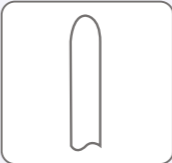

L-steel  
manche L  
art.nr. L



T-steel  
manche T  
art.nr. T

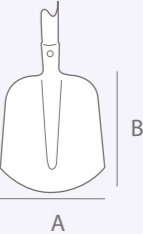

A x B x tot. lengte/long. total

7







**Schop bouw nr. 2 met gepolijste snede**  
Pelle construction nr. 2 avec tranchant poli

art.nr.	mm	unit	ref.	kg.
700.1	240x370	10	-	1
700.1E	1480	5	M104.1	2
FP700.1M	1570	5	FPM104	2

**Schop bouw nr. 2 zwart**  
Pelle construction nr. 2 noir

art.nr.	mm	unit	ref.	kg.
700.2	240x370	10	-	1
700.2B	1540	5	M104.2	2
700.2E	1480	5	M104.1	2

**Schop nr. 1 gepolijst**  
Pelle nr. 1 polie

art.nr.	mm	unit	ref.	kg.
701.1	220x360	10	-	1
701.1E	1500	10	M104.1	2

**Steekbats met T-steel**  
Pelle hollandaise avec manche T

art.nr.	mm	unit	ref.	kg.
701.STB	205x340	5	-	2

**Schop nr. 0 zwart**  
Pelle nr. 0 noir

art.nr.	mm	unit	ref.	kg.
702.0	220x340	10	-	1
702.0B	1500	5	M104.2	2
702.0E	1450	5	M104.1	2

**Schop nr. 00 zwart**  
Pelle nr. 00 noir

art.nr.	mm	unit	ref.	kg.
702.00	220x320	10	-	1
702.00B	1500	5	M104.2	2
702.00E	1450	5	M104.1	2

**Schop nr. 1 zwart**  
Pelle nr. 1 noir

art.nr.	mm	unit	ref.	kg.
702.1	220x360	10	-	1
702.1B	1540	5	M104.2	2
702.1E	1480	5	M104.1	2

**Schop nr. 3 zwart**  
Pelle nr. 3 noir

art.nr.	mm	unit	ref.	kg.
702.3	260x360	10	-	1
702.3B	1540	5	M104.2	2
702.3E	1480	5	M104.1	2

**Kabelschop**  
Pelle à câble

art.nr.	mm	unit	ref.	kg.
703	150x360	10	-	1
703.B	1540	5	M104.2	2
703.E	1480	5	M104.1	2

**Kabelschop 13cm**  
Pelle à câble 13cm

art.nr.	mm	unit	ref.	kg.
703.13	130x360	1	-	1
703.13E	130x360	1	M104.1	2

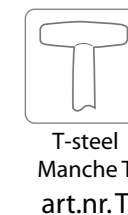
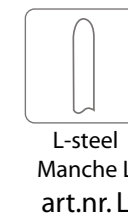





**Betonschop**  
Pelle à béton

art.nr.	mm	unit	ref.	kg.
704	260x360	10	-	1
704.B	1520	5	M104.2	2
704.E	1460	5	M104.1	2



**Zwanenhalschop**  
Pelle col de cygne

art.nr.	mm	unit	ref.	kg.
705.25	250x260	5	-	0,9
705.27	270x280	5	-	0,9
705.25B	1600	5	M104.4	1,7
705.27B	1610	5	M104.4	1,7
705.25E	1590	5	M104.3	1,7
705.27E	1600	5	M104.3	1,7



**Stalen ballastchop**  
Pelle carrée en métal

art.nr.	mm	unit	ref.	kg.
706.D	250x320x1250	5	M102.5	2



**Aluminium schop**  
Pelle aluminium

art.nr.	mm	unit	ref.	kg.
707.D	240x300x1180	5	-	1
708.D	330x380x1200	5	-	1



**Aluminium graanschop**  
Pelle à grain aluminium

art.nr.	mm	unit	ref.	kg.
709.D	320x400x1350	5	M102.11	2
709.L	320x400x1690	5	M104.1	2
709.FPL	320x400x1690	1	FPM104	2



709.FPL



**Aluminiumschop nr. 9 met stalen board**  
Pelle alu nr. 9 renforcée

art.nr.	mm	unit	ref.	kg.
710	380x390	10	-	1
710.D	1300	5	M102.3	2
710.L	1630	5	M104.1	2
710.FPL	1630	1	FPM104	2

Stalen board = art.nr. 710.RD  
PVC handvat = art.nr. M104.5



710.FPL



D-steel  
Manche D  
art.nr. D

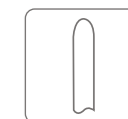

L-steel  
Manche L  
art.nr. L



T-steel  
Manche T  
art.nr. T

**Aluminium sneeuwschuiver**  
Poussoir à neige aluminium

art.nr.	mm	unit	ref.	kg.
711	550x340	12	.	0,66
711.L	550x340x1420	5	M104.1	1,55



**Kunststof sneeuwschuiver met steel**  
Pelle à neige PVC avec manche

art.nr.	mm	unit	ref.	kg.
711.2L	550	5	M104.11	1,72



**Opklapbaar schopje**  
Pelle pliable

art.nr.	mm	unit	ref.	kg.
713	max. 160x600 min. 160x240	1	-	1,15



# Gereedschap voor de bouw

## Outils pour la construction

8



artikel . article

8



### Grondboor

Tarière

art.nr.	Ø	unit	ref.	kg.
801.075	75	1	-	2
801.100	100	1	-	2

### Spiraalgrondboor

Tarière

art.nr.	Ø	unit	ref.	kg.
802.050	50	1	-	2
802.060	60	1	-	2
802.080	80	1	-	2
802.090	90	1	-	2
802.125	125	1	-	2
802.160	160	1	-	3

### Spiraalboor met verlengstuk op aanvraag verkrijgbaar

Tarières avec rallonge sur commande

(spiraalgrondboor/tarière D80 met verlengstuk = art nr 802.080+VLST)

### Asfalthark met lange huls 16 tanden

Râteau pour asphalte avec douille longue 16 dents

art.nr.	mm	unit	ref.	kg.
803.16	410	1	-	1
803.16L	410x1800	1	M104.10	2

### Asfalthark 14 tanden

Râteau pour asphalte 14 dents

art.nr.	mm	unit	ref.	kg.
803.14	400x130	1	-	1,45
803.14L	400x1600	1	M104.10	2,25

### Versterkte hark 16 tanden

Râteau renforcé 16 dents

art.nr.	mm	unit	ref.	kg.
828.16	400	1	-	1
828.16L	400x1400	5	M107.50	1,5

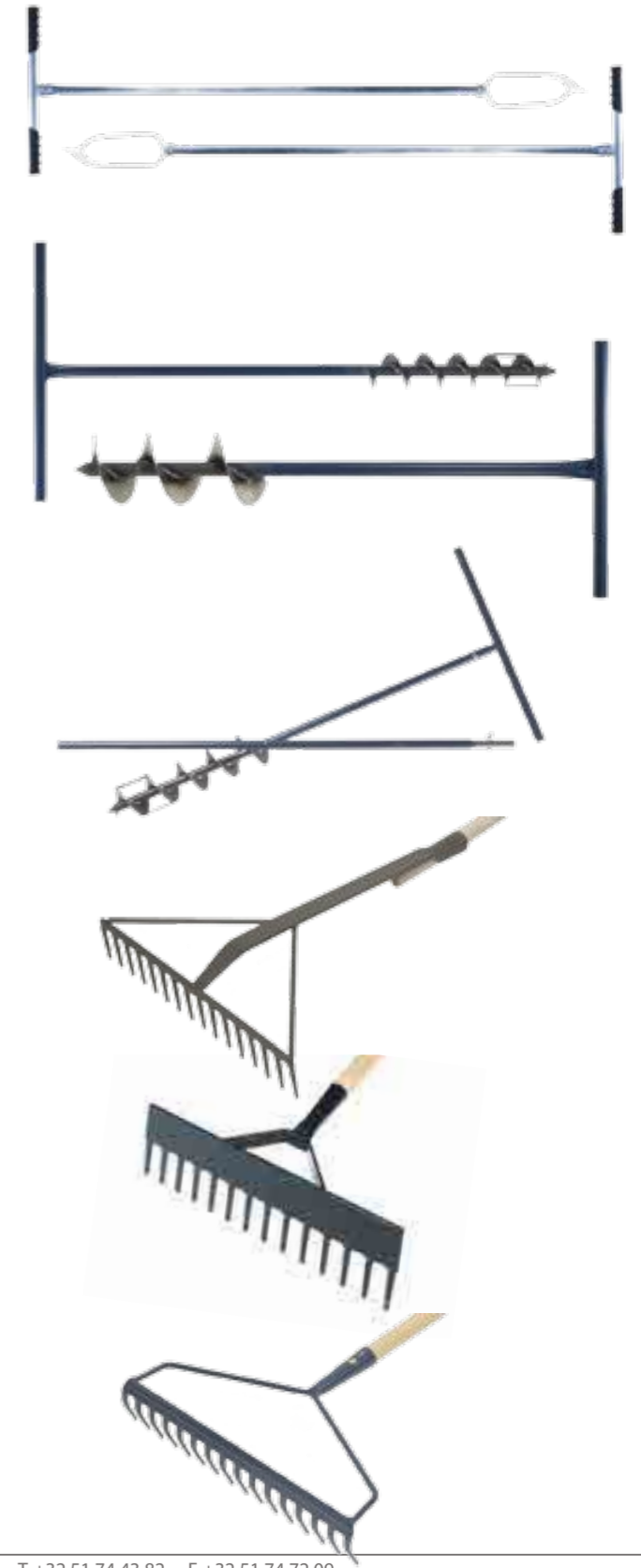

Gereedschap voor de bouw . Outils pour la construction



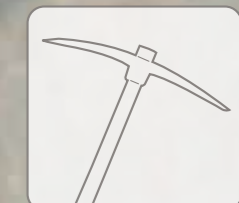

Gereedschap voor de bouw . Outils pour la construction

Gereedschap voor de bouw . Outils pour la construction



**Hamer voor kasseileggers**

Marteau de paveur

art.nr.	mm	unit	ref.	kg.
804.1	320x170x40	1	-	1,5
804.2	320x175x70	1	-	2

(vervangsteel = M113.4)

**Dalleerhamer houten blok**

Marteau de dalleur bloc en bois

art.nr.	mm	unit	ref.	kg.
805.1	210x100x320	1	-	3,16

(M113.20 = houten klos)

**Dalleerhamer nylon blok**

Marteau de dalleur bloc en nylon

art.nr.	mm	unit	ref.	kg.
805.2	215x90x320	1	-	3,1
805.3	160x80x300	1	-	3

**Gronddammer**

Dame de carreleur

art.nr.	mm	unit	ref.	kg.
806	1800x1800	1	-	9,6

**Pioche ovaal**

Pioche oeil ovale

art.nr.	mm	unit	ref.	kg.
807.1	500	1	-	2,5
807.1M	500x950	1	M110.O	3
FP807.1M	500x920	1	FPM110.O	2,5

**Pioche rond**

Pioche oeil rond

art.nr.	mm	unit	ref.	kg.
807.2	520	1	-	2,5
807.2M	520x1000	1	M110.R	3
FP807.2M	520x920	1	FPM110.R	2,5

**Pioche klein 400 gr met glasvezelsteel + PVC**

Pioche petite 400 g à manche en fibre de verre + PVC

art.nr.	mm	unit	ref.	kg.
FP807.4M	400	1	-	0,5

**Koevoet met handgreep**

Arrache-clou avec poignée

art.nr.	mm	unit	ref.	kg.
808.030	300	1	-	0,25

**Koevoet**

Arrache-clou

art.nr.	mm	unit	ref.	kg.
808.050	500x90	1	-	0,90
808.060	600x90	1	-	1,40
808.070	700x90	1	-	1,60
808.080	800x90	1	-	1,80
808.100	1000x90	1	-	2,20

**Kasseihandboom met bol en beitel prof.**

Pince de paveur à boule et burin prof.

art.nr.	mm	unit	ref.	kg.
809.1	1160	1	-	6

**Handboom met bol en beitel prof.**

Pince à boule et burin prof.

art.nr.	mm	unit	ref.	kg.
809.2	1160	1	-	6



□ 30 mm

Ø 28 mm

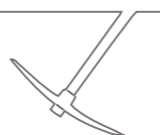

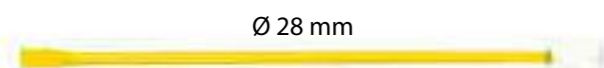

809.2ND = vervangdop voor 809.2N  
809.2ND = embout de remplacement pour 809.2N

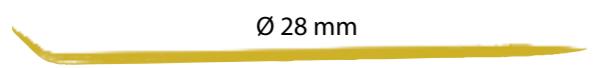
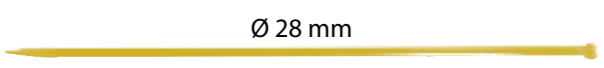
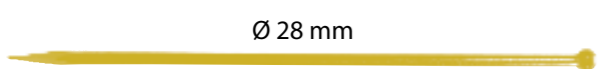

**Hefboom met bol en beitel + nylon dop**

Pince rond à burin et embout nylon

art.nr.	mm	unit	ref.	kg.
809.2N	120x28	1	.	6
809.2ND	.	1	.	.

**Hefboom met bol en punt**

Pince à boule et pointe

art.nr.	mm	unit	ref.	kg.
810.1	1200	1	-	6
810.2	1500	1	-	7

**Hefboom met voet en beitel**

Pince à talon et burin

art.nr.	mm	unit	ref.	kg.
811	1200	1	-	5

**Beitel plat**

Burin plat

art.nr.	mm	unit	ref.	kg.
813.20	200x20x10	5	-	0,5
813.25	250x25x12	5	-	0,5
813.30	300x25x12	5	-	0,5
813.35	350x25x12	5	-	0,5
813.40	400x25x12	5	-	0,5

**Dalbeitel**

Burin de carreleur

art.nr.	mm	unit	ref.	kg.
814.6	60x235	5	-	0,5
814.8	75x230	5	-	0,5

**Puntbeitel**

Burin à pointe

art.nr.	mm	unit	ref.	kg.
815	300	5	-	0,5

**Carrosseriebeitel**

Burin de carrossier

art.nr.	mm	unit	ref.	kg.
813.230	230x26x7	5	-	0,282

**Metserspriet**

Clou de maçon

art.nr.	mm	unit	ref.	kg.
816	155	40	-	0,1

**Klemhaak**

Broche de maçon

art.nr.	mm	unit	ref.	kg.
817.25	250	20	-	0,2

**Muurklem**

Valet

art.nr.	mm	unit	ref.	kg.
818	600	1	-	1,2

**Plooiijzer**

Griffe à béton

art.nr.	mm	unit	lengte	kg.
819.06/08	6/8	1	36 cm	0,30
819.10/12	10/12	1	47 cm	0,74
819.14/16	14/16	1	53 cm	1,1
819.18/20	18/20	1	70 cm	1,4

**Betonschraper**

Racloir à béton

art.nr.	mm	unit	ref.	kg.
823	300	1	-	1
823.L	300x1380	1	M104.3	1,8

**Afsteekmes**

Grattoir de coffrage

art.nr.	mm	unit	ref.	kg.
824	300	1	-	0,9
824.L	300x1500	1	M104.3	1,7
824.T	300x1050	1	M101.5	1,5
824.50	500	10	-	1,2
824.50L	500x1500	5	M104.3	2
824.50T	500x1050	5	M101.5	1,8

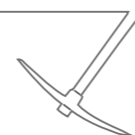



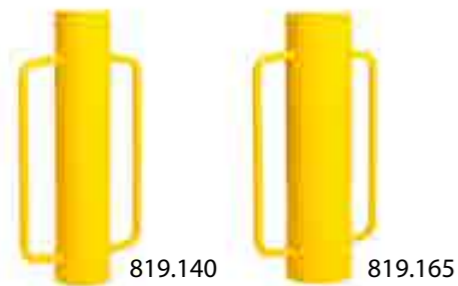

819.140

819.165

**Palenhamer**

Pilon piquets

art.nr.	mm	unit	ref.	kg.
819.140	140	1	.	15,5
819.165	165	10	.	18,4

**Moker**

Massette



art.nr.	mm	unit	ref.	kg.
825.1	100x260	10	M113.90	1
825.2	100x260	10	M113.90	1,25

**Voorhamer**

Masse

H : Hickory  
M : Es - Frêne

art.nr.	mm	unit	ref.	kg.
826.3H	140x900	1	M111.2	3
826.3M	140x900	1	M111.1	3
826.4H	150x900	1	M111.2	4
826.4M	150x900	1	M111.1	4
826.5H	170x900	1	M111.2	5
826.5M	170x900	1	M111.1	5

**Voorhamer met dwarse punt**

Masse panne en travers



art.nr.	mm	unit	ref.	kg.
826.6M	185x900	1	M111.1	3
826.7M	185x900	1	M111.1	4
826.8M	185x900	1	M111.1	5

**Ronde metalen spie**

Coin rond à emmancher



art.nr.	mm	unit	ref.	kg.
M203	ø 23x26	1	vrac	0,03
M203.1	ø 18x25	1	vrac	0,02
M203.B	2xM203 + 2xM203.1	10	blister 4pc	0,11
M204.B	4xM203.1	10	blister 4pc	0,08

**Schaliedekkershamer rechts met ledergreep**

Marteau d'ardoisier droite avec poignée en cuir

art.nr.	mm	unit	ref.	kg.
820.1	400	1	-	0,68

**Vlak aambeeld met geslepen zijde & gebogen punt**

Enclume droit avec bords polis &amp; point courbé

art.nr.	mm	unit	ref.	kg.
821	.	1	-	0,56

**Schaliedekkershaak**

Clou d'ardoisier

art.nr.	mm	unit	ref.	kg.
822	470	1	-	0,78

**Rubber handbescherming voor platte beitel**

Poignée caoutchouc pour burin plat

art.nr.	mm	unit	ref.	kg.
813.001	-	1	-	0,2

**Plooiometer met ingebouwde metalen scharnieren 2M PRO 90°**

Pli mètres avec charnières métalliques incorporées 2M PRO 90°

art.nr.	mm	unit	ref.	kg.
829.01	2000	10	-	0,105







*Goed gereedschap is het halve werk.*



**Metselen, vloeren & pleisteren**  
**Maçonnerie, carrelage & plâtrage**

9

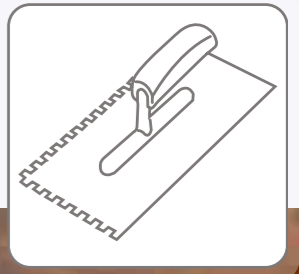



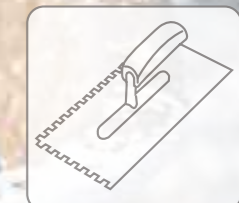

**Metserstruweel Brussel - conisch gepolijst**  
Truelle de maçon Bruxelles - polie conique

art.nr.	mm	unit	mm	kg.
901.1	180	1	1,8 - 1,2	0,43
901.1P	180	1	1,8 - 1,2	0,43



**Metserstruweel Floreffe - conisch gepolijst**  
Truelle de maçon Floreffe - polie conique

art.nr.	mm	unit	mm	kg.
901.2	180	1	1,8 - 1,2	0,42
901.2P	180	1	1,8 - 1,2	0,42



**Metserstruweel Charleroi - conisch gepolijst**  
Truelle de maçon Charleroi - polie conique

art.nr.	mm	unit	mm	kg.
901.3	180	1	1,8 - 1,2	0,4
901.3P	180	1	1,8 - 1,2	0,4



**Metserstruweel Parijs - conisch gepolijst**  
Truelle de maçon Paris - polie conique

art.nr.	mm	unit	mm	kg.
901.4	180	1	1,8 - 1,2	0,4
901.4P	180	1	1,8 - 1,2	0,4



**Vloerderstruweel - conisch gepolijst**  
Truelle de carreleur - polie conique

art.nr.	mm	unit	mm	kg.
902	170	1	1,8 - 1,2	0,36
902.P	170	1	1,8 - 1,2	0,36



**Plakkerstruweel gepolijst**  
Truelle de plâtriers polie

art.nr.	mm	unit	mm	kg.
903.1	180	1	1,2	0,34
903.1P	180	1	1,2	0,34



**Plakkerstruweel Inox**  
Truelle de plâtriers en Inox

art.nr.	mm	unit	mm	kg.
903.2	180	1	1,0	0,30



**Polierstruweel - conisch gepolijst**  
Truelle à polir - polie conique

art.nr.	mm	unit	mm	kg.
904.12	115	1	1,1 - 0,8	0,32
904.12P	115	1	1,1 - 0,8	0,32



**Polierstruweel - conisch gepolijst**  
Truelle à polir - polie conique

art.nr.	mm	unit	mm	kg.
904.14	140	1	1,1 - 0,7	0,14
904.14P	140	1	1,1 - 0,7	0,14



**Polierstruweel - conisch gepolijst**  
Truelle à polir - polie conique

art.nr.	mm	unit	mm	kg.
904.16	160	1	1,1 - 0,65	0,16
904.16P	160	1	1,1 - 0,65	0,16



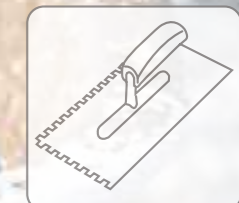

**Poliertruweel - conisch gepolijst**

Truelle à polir - polie conique

art.nr.	mm	unit	mm	kg.
904.18	180	1	1,1 - 0,65	0,16
904.18P	180	1	1,1 - 0,65	0,16



**Kattetong**

Langue de chat

art.nr.	mm	unit	mm	kg.
905.12	120	1	1,1	0,12
905.14	140	1	1,1	0,12
905.16	160	1	1,0 - 0,7	0,13



**Schaliedekkerstruweel**

Truelle d'ardoisier

art.nr.	mm	unit	mm	kg.
906	200x25	1	1,1	0,16



**Voeger met ronde hals - conisch gepolijst**

Fer à rejointoyer rond - polie conique

art.nr.	mm	unit	mm	kg.
907.08	8	1	1,8 - 1,0	0,1
907.10	10	1	1,8 - 1,0	0,1

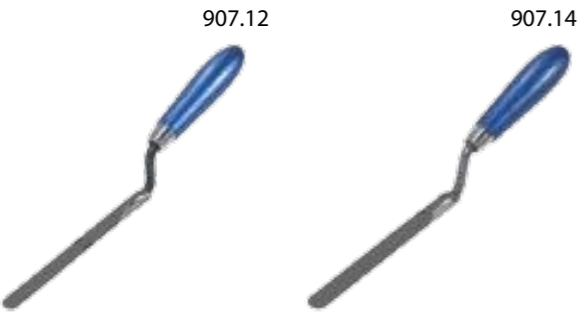

**Voeger met ronde hals - conisch gepolijst**

Fer à rejointoyer rond - polie conique

art.nr.	mm	unit	mm	kg.
907.12	12	1	1,8 - 1,0	0,1
907.14	14	1	1,8 - 1,0	0,1



**Voeger met ronde hals PVC handvat - conisch gepolijst**

Fer à rejointoyer rond poignée PVC - polie conique

art.nr.	mm	unit	mm	kg.
907.10P	10	1	1,8 - 1	0,1
907.12P	12	1	1,8 - 1	0,1
907.14P	14	1	1,8 - 1	0,1



**Vaste voeger met extra sterk blad**

Fer à rejointoyer plat avec lame ultradure

art.nr.	mm	unit	mm	kg.
908.08	8	1	2,5	0,08
908.10	10	1	2,5	0,08
908.12	12	1	2,5	0,1
908.14	14	1	2,5	0,1



**Voegerspalet**

Palette de retouche

art.nr.	mm	unit	mm	kg.
909.1	150x230	1	0,8	0,350
909.2	150x230	1	0,8	0,350



**Hoektruweel**

Truelle pour coin

art.nr.	mm	unit	mm	kg.
910.1	60x80	1	1,2	0,18
910.2	60x80	1	1,2	0,18



**Pleistertruweel rond**

Plâtresse ronde

art.nr.	mm	unit	mm	kg.
911.1	280x110/80	1	1,0	0,3
911.1P	280x110/80	1	0,8	0,3





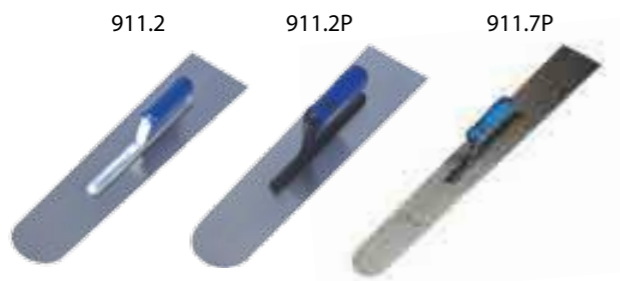
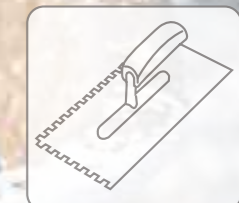

**Plakspaan rond**  
Plâtresse ronde

art.nr.	mm	unit	mm	kg.
911.2	500x110/80	1	1,0	0,6
911.2P	500x110/80	1	0,8	0,6
911.7P	750x110/80	1	1,2	0,9

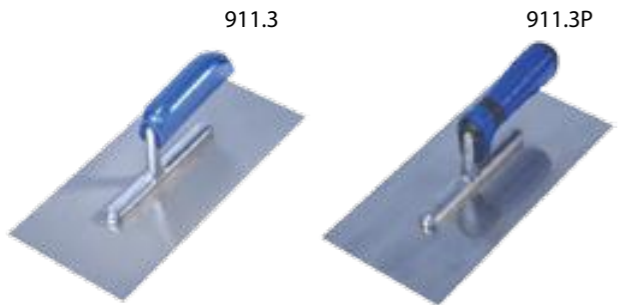

**Pleistertruweel**  
Plâtresse

art.nr.	mm	unit	mm	kg.
911.3	280x130	1	0,7	0,32
911.3P	280x130	1	0,7	0,32



**Pleistertruweel Inox**  
Plâtresse Inox

art.nr.	mm	unit	mm	kg.
911.4	280x130	1	0,7	0,34

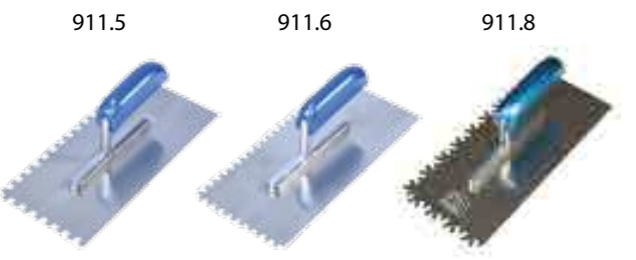

**Pleistertruweel getand**  
Plâtresse dentée

art.nr.	mm	unit	mm	kg.
911.5	280x130-6x6	1	0,7	0,33
911.6	280x130-8x8	1	0,7	0,33
911.8	280x130	1	0,7	0,33



**Strijkbord**  
Taloche

art.nr.	mm	unit	mm	kg.
912.1	280x140	1	-	0,35
912.2	280x140	1	-	0,35

**Insulknife**  
Insulknife

art.nr.	mm	unit	ref	kg.
505.11	400	1	-	0,6
505.12	-	1	-	0,12



505.12 Sharpener

**Spoelbak pro set 23L ( incl. 930.030 )**  
Bac de rinçage pro set 23L ( incl. 930.030 )

art.nr.	mm	unit	ref	kg.
930.010	-	1	-	2,5



**Spoelbak zwart set 23L ( incl. 930.030 )**  
Bac de rinçage noir set 23L ( incl. 930.030 )

art.nr.	mm	unit	ref	kg.
930.020	-	1	-	2,4



**Onderdelen spoelbak**  
Pièces détachées pour bac de rinçage

art.nr.	mm	unit	ref	kg.
930.030	-	1	-	0,25
930.031	-	1	-	0,50
930.032	-	1	-	0,2





941.26 940.26

**Flexi tub 26L**  
Tub flexi 26L

art.nr.	liter	unit	mm	kg.
940.26	26L	10	-	0,83
941.26	26L	10	-	0,83
942.26	26L	10	-	0,83



942.26



941.42 940.42

**Flexi tub 42L**  
Tub flexi 42L

art.nr.	liter	unit	mm	kg.
940.42	42L	10	-	0,95
941.42	42L	10	-	0,95
942.42	42L	10	-	0,95



942.42

**Gereedschap met glasvezelsteel**

**Outils avec manche en fibre**

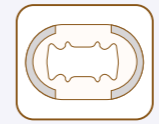

PVC steel met glasvezelkern  
Manche PVC avec noyau en fibre de verre  
art.nr. FP

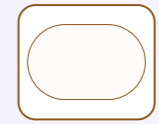

Volle glasvezelsteel  
Manche en fibre de verre homogène  
art.nr. F

10

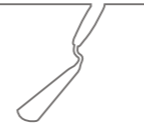





Gereedschap met glasvezelsteel . Outils en fibre

Gereedschap met glasvezelsteel . Outils en fibre



**Bankhamer met glasvezelsteel DIN 1041**  
Marteau d'ajusteur avec manche en fibre DIN 1041

art.nr.	mm	unit	ref.	kg.
F10.500	340	5	-	0,5
F10.600	340	5	-	0,6
F10.800	340	5	-	0,8



**Bankhamer met glasvezelsteel DIN 1041**  
Marteau d'ajusteur avec manche en fibre DIN 1041

art.nr.	mm	unit	ref.	kg.
F10.500	340	5	-	0,5
F10.600	340	5	-	0,6
F10.800	340	5	-	0,8



**Bankhamer met glasvezelsteel DIN 1041**  
Marteau d'ajusteur avec manche en fibre DIN 1041

art.nr.	mm	unit	ref.	kg.
F11.000	340	5	-	1
F11.500	360	5	-	1,5
F12.000	370	5	-	2



**Klauwhamer met glasvezelsteel**  
Marteau de charpentier avec manche en fibre

art.nr.	mm	unit	ref.	kg.
F20.000	340	5	-	0,5



**Moker met glasvezelsteel DIN 6475**  
Massette avec manche en fibre DIN 6475

art.nr.	mm	unit	ref.	kg.
F31.000	320	5	-	1
F31.250	320	5	-	1,25
F31.500	320	5	-	1,5
F32.000	380	5	-	2

**Voorhamer vierkant met glasvezelsteel DIN 1042**  
Masse carrée avec manche en fibre DIN 1042

art.nr.	mm	unit	ref.	kg.
F41.300	920	5	-	3
F41.400	920	5	-	4
F41.500	920	5	-	5



**Voorhamer dwarse snede met glasvezelsteel DIN 1042**  
Masse panne en travers avec manche en fibre DIN 1042

art.nr.	mm	unit	ref.	kg.
F42.300	920	5	-	3
F42.400	920	5	-	4
F42.500	920	5	-	5



**Moker met glasvezelsteel + PVC**  
Masse avec manche en fibre de verre + PVC

art.nr.	mm	unit	ref.	kg.
FP31.200	280	1	-	1,2



**Voorhamer vierkant met glasvezelsteel + PVC**  
Masse carrée avec manche en fibre de verre + PVC

art.nr.	mm	unit	ref.	kg.
FP41.300	920	1	FPM111	3
FP41.400	920	1	FPM111	4
FP41.500	920	1	FPM111	5



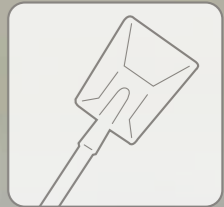

11

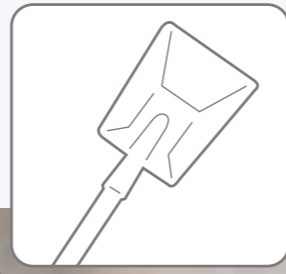

### Kinderspade metaal

Bêche métal pour enfants

art.nr.	mm	unit	ref.	kg.
K101	900	10	-	0,5



### Kinderschop metaal

Pelle métal pour enfants

art.nr.	mm	unit	ref.	kg.
K102	900	10	-	0,5



### Kinderbladrijf metaal

Balai à feuillage métal pour enfants

art.nr.	mm	unit	ref.	kg.
K103	1000	10	-	0,5



### Kinderhark metaal

Râteau métal pour enfants

art.nr.	mm	unit	ref.	kg.
K104	800	10	-	0,5



### Kinderborstel

Balai terrasse pour enfants

art.nr.	mm	unit	ref.	kg.
K105	820	10	-	0,5







**Driewieler Metafox hout**  
Tricyclette Metafox en bois

art.nr.	mm	unit	ref.	kg.
K120	600x550x450	1	-	4



In meerdere kleuren verkrijgbaar  
Disponible en plusieurs couleurs



**Kinderhandschoenen**  
Gants d'enfants

art.nr.	mm	unit	ref.	kg.
K502	-	1	-	1,9
K502.4/5	4-6 J/A	12	-	0,04
K502.6/8	6-8 J/A	12	-	0,05
K502.8/10	8-10 J/A	12	-	0,05

K502 = display = 3x12 = 36 st./pcs.

## Stelen en toebehoren

### Manches et accessoires

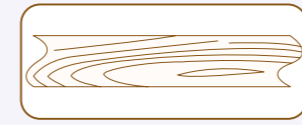

steel Es  
Manche Frêne  
code E

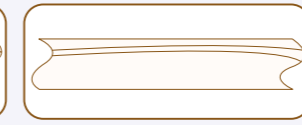

steel Beuk  
manche Hêtre  
code B

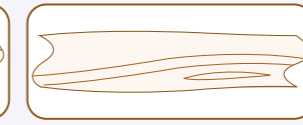

steel HICKORY  
Manche HICKORY  
code H

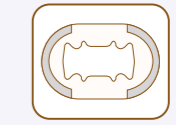

PVC steel met glasvezelkern  
Manche PVC avec noyau en  
fibre de verre  
code FP

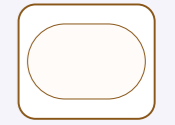

Voile glasvezelsteel  
Manche en fibre de  
verre homogène  
code F

12





Stelen en toebehoren . Manches et accessoires

Stelen en toebehoren . Manches et accessoires



**T-steel gescherpt en doorgewerkt**  
Manche T pointu et mortaisé

art.nr.	mm	unit	code	kg.
M101.1	900	12	E	0,5



**T-steel glasvezel + PVC**  
Manche T fibres de verre + PVC

art.nr.	mm	unit	code	kg.
FPM101	940	1	FP	1



**T-steel glasvezel vol**  
Manche T fibres de verre homogène

art.nr.	mm	unit	code	kg.
M101.F	900	1	F	1



**T-steel doorgewerkt voor 103**  
Manche T mortaisé pour 103

art.nr.	mm	unit	code	kg.
M101.2	870	12	E	0,5



**T-steel doorgewerkt**  
Manche T mortaisé

art.nr.	mm	unit	code	kg.
M101.3	1000	12	E	0,5



**T-steel hickory voor boomspade 113.TH**  
Manche T hickory pour bêche d'arboriculture 113.TH

art.nr.	mm	unit	code	kg.
M101.4H	900	5	H	1



**T-steel niet gescherpt voor spade 106.T**  
Manche T pas pointu pour bêche 106.T

art.nr.	mm	unit	code	kg.
M101.5	900	12	E	0,5



**T-steel gebogen voor spade 105.T**  
Manche T courbé pour bêche 105.T

art.nr.	mm	unit	code	kg.
M101.6	900	12	E	0,5

**T-greepsteel met metalen huls**  
Manche T pour fourche avec douille en métal

art.nr.	mm	unit	code	kg.
M101.7	870	5	E	1

**T-steel voor gazonafboorder**  
Manche T pour coupe bordure

art.nr.	mm	unit	code	kg.
M101.8	950	5	E	0,5

**D-steel uit 1 stuk**  
Manche D d'une pièce

art.nr.	mm	unit	code	kg.
M102.1	900	1	E	1

**D-steel glasvezel vol**  
Manche D fibre de verre homogène

art.nr.	mm	unit	code	kg.
M102.F	900	1	F	1

**D-steel gebogen met ijzeren handvat**  
Manche D courbé avec poignée en fer

art.nr.	mm	unit	code	kg.
M102.2	970	6	E	1

**D-steel gebogen met handvat in PVC**  
Manche D courbé avec poignée en PVC

art.nr.	mm	unit	code	kg.
M102.3	1030	6	E	1

**D-greepsteel gebogen met metalen huls**  
Manche D courbé pour fourche avec douille en métal

art.nr.	mm	unit	code	kg.
M102.4	860	5	E	1

**D-greepsteel recht voor art. 706**  
Manche D droit pour fourche pour art 706

art.nr.	mm	unit	code	kg.
M102.5	1000	6	E	1







**Handvat D in PVC**  
Poignée D en PVC

art.nr.	mm	unit	code	kg.
M104.5	180x115	1	-	0,16



**Ijzeren handvat D met houten greep**  
Poignée D en fer et bois

art.nr.	mm	unit	code	kg.
M104.7	200x120	1	-	0,34



**Bolsteel recht**  
Manche boule droit

art.nr.	mm	unit	code	kg.
M103.1	1111	1	E	1



**Bolsteel gebogen**  
Manche boule courbé

art.nr.	mm	unit	code	kg.
M103.2	1040	1	E	1



**Schopsteel gebogen - es**  
Manche de pelle courbé - frêne

art.nr.	mm	unit	code	kg.
M104.1	1300	25	E	0,8



**Schopsteel gebogen - beuk**  
Manche de pelle courbé - hêtre

art.nr.	mm	unit	code	kg.
M104.2	1300	25	B	1



**Schopsteel recht - es**  
Manche de pelle droite - frêne

art.nr.	mm	unit	code	kg.
M104.3	1300	12	E	1



**Schopsteel recht - beuk**  
Manche de pelle droit - hêtre

art.nr.	mm	unit	code	kg.
M104.4	1300	12	B	1

**Schopsteel gebogen - glasvezel en nylon**  
Manche de pelle courbé - fibre et nylon

art.nr.	mm	unit	code	kg.
FPM104	1350	1	FP	0,95



**Schopsteel recht - glasvezel en nylon**  
Manche de pelle droit - fibre et nylon

art.nr.	mm	unit	code	kg.
FPM104.3	1350	1	FP	0,95



**Steel voor snoestek ref 210 (& 803.16 & 803.14 & 604)**  
Manche pour serpette ref 210 (& 803.16 & 803.14 & 604)

art.nr.	mm	unit	code	kg.
M104.10	1300	1	E	0,75



**Borstelsteel Ø 23,5 mm**  
Manche de brosse Ø 23,5 mm

art.nr.	mm	unit	code	kg.
M105.20	1200	25	PE	0,2
M105.40	1400	25	PE	0,2



**Harksteel gepunt Ø 28 mm**  
Manche de râteau pointu Ø 28 mm

art.nr.	mm	unit	code	kg.
M106.30	1300	25	PE	0,35
M106.40	1400	25	PE	0,38
M106.50	1500	25	PE	0,41
M106.70	1700	5	PE	0,46



PE = Pinus Elliotis

**Biethaksteel Ø 30 mm**  
Manche de binette pointu Ø 30 mm

art.nr.	mm	unit	code	kg.
M107.50	1500	25	E	0,68

**Harksteel gepunt Ø 28 mm - glasvezel en nylon**  
Manche de râteau pointu Ø 28 mm - fibre et nylon

art.nr.	mm	unit	code	kg.
FPM160.50	1500	20	FP	0,6

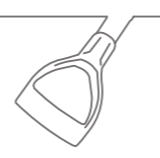



**Schoffelsteel met hilt**  
Manche T hollandaise pour ratissoire à pousser

art.nr.	mm	unit	code	kg.
M107.160	1600	1	E	0,67



**Haksteel**  
Manche de rasette

art.nr.	mm - Ø	unit	code	kg.
M108.40	1300 - 40	12	B	1
M108.45	1300 - 45	1	B	1
M108.50	1300 - 50	1	B	1



**Greepsteel gebogen met metalen huls**  
Manche de fourche courbé avec douille en métal

art.nr.	mm	unit	code	kg.
M109.130	1300	1	E	0,5

Stiftverbinding



**Vorksteel recht met metalen huls**  
Manche de fourche droit avec douille en métal

art.nr.	mm	unit	code	kg.
M109.230	1300	1	E	0,6
M109.250	1500	1	E	0,78
M109.265	1650	1	E	0,88

Stiftverbinding



**Metalen huls met kapje**  
Douille en métal

art.nr.	mm	unit	code	kg.
M109.400	225	1	-	0,2



**Piochesteel**  
Manche de pioche

art.nr.	mm - Ø	unit	code	kg.
M110.O	950 - 63x44	6	E	1
FPM110.O	920 - 55x40	1	FP	1
M110.R	1000 - 50x50	6	eucaliptus	1
FPM110.R	920 - 50x50	1	FP	1

Ovaal . Ovale



Rond . Rond

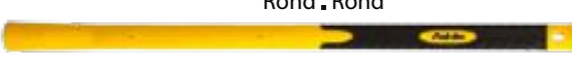

**Voorhamersteel**  
Manche de masse

art.nr.	mm - Ø	unit	code	kg.
M111.1	900 - 45x33	6	E	1
M111.2	900 - 44x32	12	H	1
M111.3	900 - 47x35	12	H	1



**Voorhamersteel glasvezel + PVC**  
Manche de masse fibre de verre + PVC

art.nr.	mm - Ø	unit	code	kg.
FPM111	920 - 49x32	1	FP	1,05



(ook voor ref.206)

**Kliefhamersteel**  
Manche de merlin

art.nr.	mm	unit	code	kg.
M112.1	890	6	E	1
M112.2	890	6	H	1



**Bijlsteel lang**  
Manche de hache long

art.nr.	mm	unit	code	kg.
M112.3	30x70x900	1	E	1
M112.4	25x65x800	1	E	1



**Bijlsteel kort**  
Manche de hache court

art.nr.	mm	unit	code	kg.
M112.5	370	1	E	0,2
M112.6	400	1	E	0,2
M112.7	380	1	E	0,2



**Hakmessteel**  
Manche pour couperet

art.nr.	mm	unit	code	kg.
M113.1	160	1	B	0,2







**Vijlsteel**  
Manche de lime

art.nr.	mm	unit	code	kg.
M113.08	80	1	E	0,05
M113.10	100	1	E	0,05
M113.12	120	1	E	0,05
M113.14	140	1	E	0,05
M113.16	160	1	E	0,05



**Mokersteel**  
Manche pour masse

art.nr.	mm	unit	code	kg.
M113.90	300	1	E	0,2



**Tuinhamer met metalen ringen**  
Maillet en bois avec anneaux en métal

art.nr.	mm	unit	code	kg.
M114.1	1000	1	E	4



**Tuinhamersteel**  
Manche pour maillet

art.nr.	mm	unit	code	kg.
M114.2	1000	1	E	0,5



**Tuinhamer rubber blok**  
Maillet en caoutchouc

art.nr.	mm	unit	code	kg.
M114.3	1120	1	E	3,5



**Ophangstelsysteem rail 50 cm + 3 clips**  
Porte-outils rail 50 cm + 3 clips

art.nr.	mm	unit	code	kg.
M401	500	1	-	0,35



**Ophangstelsysteem rail 90 cm + 5 clips**  
Porte-outils rail 90 cm + 5 clips

art.nr.	mm	unit	code	kg.
M402	900	1	-	0,55



**Clip (per 2)**  
Clip (par 2)

art.nr.	Ø	unit	code	kg.
M403	20-30	1	-	0,114
M404	30-40	1	-	0,126



**Haak voor alu-rail 3st./verpakking**  
Crochet pour alu-rail 3pcs/emballage

art.nr.	mm	unit	code	kg.
M405	-	3	-	0,024



**Stratenmakershandschoen prof. Large**  
Gants de paveur grande taille prof.

art.nr.	taille	unit	code	kg.
M502.1	10	1	-	0,2



**Tuinhandschoenen prof. Medium**  
Gants jardin prof. taille Moyen

art.nr.	taille	unit	code	kg.
M502.2	9	1	-	0,2



**Tuinhandschoenen met canvasgrip Medium**  
Gants de jardin en canevas taille Moyen

art.nr.	taille	unit	code	kg.
M502.4	10	1	-	0,2





**Werkhandschoen large**

Gants grande taille

art.nr.	taille	unit	code	kg.
M502.3	10	1	-	0,2



**Handschoenen Thermo foam**

Gants Thermo foam

art.nr.	taille	unit	code	kg.
M502.7	7	12	.	0,045
M502.8	8	12	.	0,050
M502.9	9	12	.	0,050
M502.10	10	12	.	0,065
M502.11	11	12	.	0,070



**Vol wiel PU 300-4 zonder lager**

Roue pleine PU 300-4 sans roulement

art.nr.	taille	unit	code	kg.
MADCW3004	300-4	1	-	0,7

velgbreedte/largeur 75 mm  
diameter as/diamètre axe ø 20mm

**Borstels en toebehoren**

**Brosses et accessoires**

13







Borstels en toebehoren . Brosses et accessoires

Borstels en toebehoren . Brosses et accessoires



**Kokosveger 33 cm vernist (zonder steel)**

Balai en coco 33 cm verni (sans manche)

art.nr.	mm	unit	ref.	kg.
M600.33	330	5	(M605.1)	0,488



M600.40



M600.50



M600.60



M600.80

**Kokosveger (zonder steel)**

Balai en coco (sans manche)

art.nr.	mm	unit	ref.	kg.
M600.40	400	5	(M105.40)	0,56
M600.50	500	5	(M605)	0,7
M600.60	600	5	(M105.40)	0,87
M600.80	800	5	(M106.40)	1,55



**Bezem PVC groen + steelhouder (zonder steel)**

Balai PVC vert + douille (sans manche)

art.nr.	mm	unit	ref.	kg.
M601.30	300	5	(M605)	0,43
M601.40	400	5	(M605)	0,585
M601.50	500	5	(M605)	0,670
M601.60	600	5	(M605)	0,815



**Tuinbezem Laura PVC groen + steelhouder (zonder steel)**

Balai de jardin Laura PVC vert + douille (sans manche)

art.nr.	mm	unit	ref.	kg.
M602.1	240	5	(M605)	0,33



**Veegborstel Sara PVC groen + steelhouder (zonder steel)**

Balai Sara PVC vert + douille (sans manche)

art.nr.	mm	unit	ref.	kg.
M602.2	280	5	(M605)	0,28

**Veger PVC zwart + steelhouder (zonder steel)**

Balai PVC noir + douille (sans manche)

art.nr.	mm	unit	ref.	kg.
M603.30	300	5	(M605)	0,45
M603.40	400	5	(M605)	0,6
M603.60	600	5	(M605)	0,85



**Straatbezem PVC rood (zonder steel)**

Balai de rue PVC rouge (sans manche)

art.nr.	mm	unit	ref.	kg.
M604.29	290	5	(M106.40)	0,44
M604.40	400	5	(M107.50)	0,725



**Straatveger PVC / mengeling 31cm**

Balai de rue PVC / mélange 31cm

art.nr.	mm	unit	ref.	kg.
M604.37	310	4	(M107.50)	0,85



**Metaalsteel groen gelakt**

Manche en métal vert

art.nr.	mm	unit	ref.	kg.
M605	1300	1	-	0,2
M605.1	1300	1	-	0,2

M605 Borstelsteel / Manche de brosse  
M605.1 Trekkersteel / Manche de balai de séchage



**Handborstel PPN**

Balayette en PPN

art.nr.	mm	unit	ref.	kg.
M606.1	300	5	-	0,225







**Handveger kokos 4R vernist**  
Balayette avec coco 4R vernie

art.nr.	mm	unit	ref.	kg.
M606.2	300	5	-	0,24



**Stofblik metaal met houten steel**  
Pelle à poussière en métal avec manche en bois

art.nr.	mm	unit	ref.	kg.
M606.3	220x230	5	-	0,40



**Kolenschop metaal met houten steel**  
Pelle à charbon en métal avec manche en bois

art.nr.	mm	unit	ref.	kg.
M606.4	120x230	3	-	0,34



**Stofblik met lip + handborstel 'soft grip'**  
Pelle à poussière + set 'soft grip'

art.nr.	mm	unit	ref.	kg.
M606.5	220x230	4	-	0,27



**Handschrobber met 'soft grip'**  
Brosse à récurer 'soft grip'

art.nr.	mm	unit	ref.	kg.
M608.1	140	4	-	0,18

**Rubberborstel met telescopische steel 'soft grip'**  
Brosse en caoutchouc avec manche télescopique 'soft grip'

art.nr.	mm	unit	ref.	kg.
M608.2	300	4	-	0,54



**Rubberveger voeding met witte mousse (zonder steel)**  
Balai de séchage mousse blanche (sans manche)

art.nr.	mm	unit	ref.	kg.
M609.35	350	5	(M605.1)	0,1
M609.45	450	5	(M605.1)	0,12
M609.55	550	5	(M605.1)	0,3



**Vloerwisser metaal en rubber (zonder steel)**  
Raquette en métal et caoutchouc noir (sans manche)

art.nr.	mm	unit	ref.	kg.
M610.35	350	10	(M105.40)	0,16
M610.45	450	10	(M105.40)	0,20
M610.60	600	10	(M105.40)	0,30



Alle artikelen zijn zonder steel, tenzij anders vermeld.  
Tous les articles sont sans manche, sauf autrement mentionné

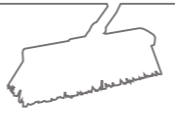





*De Pypere koop je voor het leven.*

## Sproeimateriaal . Outils d'arrosage

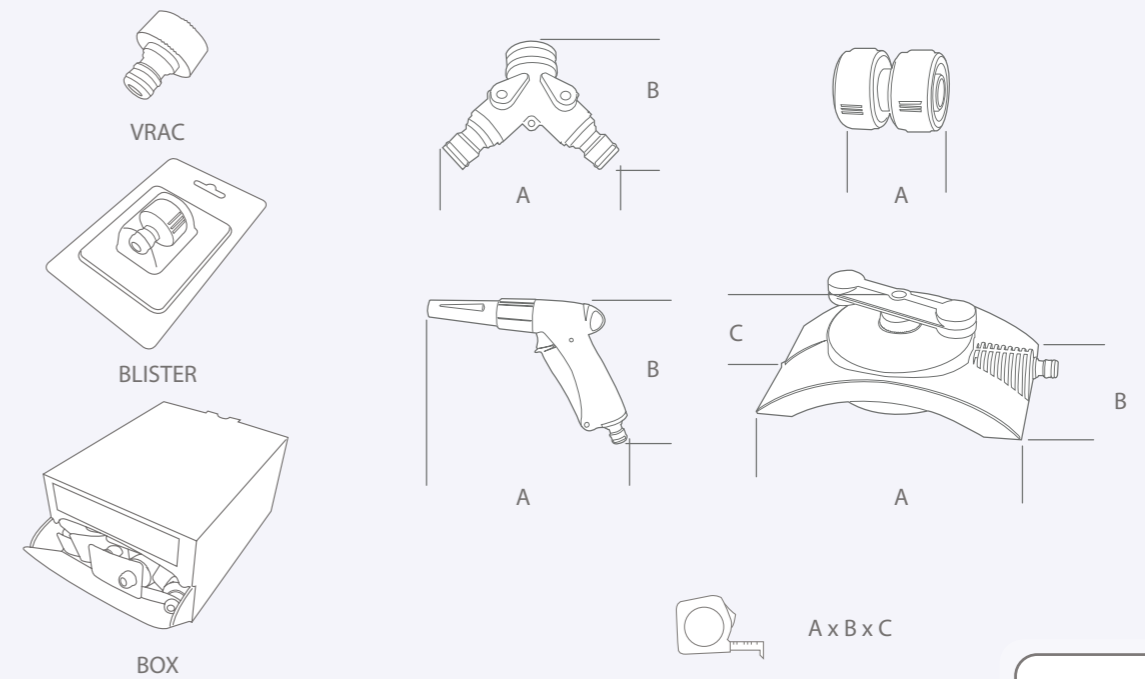

14

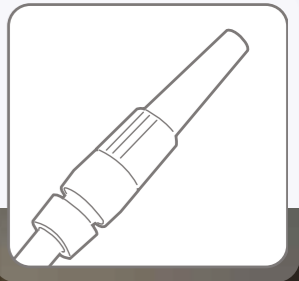



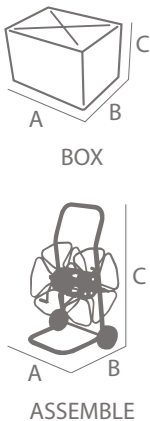

**Tuinslang geel**  
Tuyau d'arrosage jaune

art.nr.	m - Ø	unit	ref.	kg.
DP02125	25 - 1/2"	1	vrac	3,1
DP02150	50 - 1/2"	1	vrac	6,0
DP02225	25 - 5/8"	1	vrac	3,5
DP02250	50 - 5/8"	1	vrac	6,5
DP02325	25 - 3/4"	1	vrac	6,5
DP02350	50 - 3/4"	1	vrac	10,5
DP02450	50 - 1"	1	vrac	17,5

**Haspel DP metaal 50m 5/8" - 75m 1/2"**  
Dévidoir DP métal 50m 5/8" - 75m 1/2"

art.nr.	mm	unit	ref.	kg.
DP6010	555x210x430	1	box	8
DP6010.M	620x420x925	1	assemblé	8

**Haspel DP metaal 50m 3/4"**  
Dévidoir DP métal 50m 3/4"

art.nr.	mm	unit	ref.	kg.
DP6020	520x220x670	1	box	9
DP6020.M	650x480x930	1	assemblé	9

**Haspel prof op volle banden 50m 1"**  
Dévidoir prof. roues pleines 50m 1"

art.nr.	mm	unit	ref.	kg.
DP6030	770x230x600	1	box	12
DP6030.M	820x600x930	1	assemblé	12



**Haspel prof op volle banden 100m 3/4"**  
Dévidoir prof. roues pleines 100m 3/4"

art.nr.	mm	unit	ref.	kg.
DP6031	770x240x600	1	box	12
DP6031.M	820x600x930	1	assemblé	12

**Haspel prof luchtbanden 100m 1"**  
Dévidoir prof. roues pneumatiques 100m 1"

art.nr.	mm	unit	ref.	kg.
DP6040	770x240x600	1	box	15
DP6040.M	820x1100x1060	1	assemblé	15

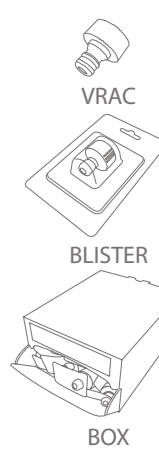

Ipierre Metaal / Métal

**Dubbele nippel**  
Mamelon double

art.nr.	mm	unit	ref.	kg.
S902005	45	12	blister	0,07



**Y vertakking met 2 nippels en 3/4" koppeling - regelbaar**  
Branchement Y avec 2 mamelons et raccord 3/4" - réglable

art.nr.	mm	unit	ref.	kg.
S902006	95x70	25	blister	0,37







**Regelbare spuit**  
Lance réglable

art.nr.	mm	unit	ref.	kg.
S902009	95	20	blister	1,5



**Impulssproeier**  
Arroseur à impulsion

art.nr.	mm	unit	ref.	kg.
S2063	100x100	1	blister	0,25

H<sub>2</sub>O 4 bar: ø 24 m



**Voet gegalvaniseerd voor impulssproeier S2063**  
Traîneau tubulaire galvanisé pour arroseur S2063

art.nr.	mm	unit	ref.	kg.
S2803	375x280x95	1	blister	1,08



**Regelbaar spuitpistool**  
Pistolet réglable avec lance réglable

art.nr.	mm	unit	ref.	kg.
S902975	120x160	10	blister	0,36



**Nippel 3/4" mannelijk**  
Mamelon 3/4" mâle

art.nr.	mm	unit	ref.	kg.
S902201	35	25	blister	0,06

**Nippel 3/4" vrouwelijk**  
Mamelon 3/4" femelle

art.nr.	mm	unit	ref.	kg.
S902204	35	20	blister	0,06

**Reparatiekoppeling 1/2"**  
Réparateur autoserrant 1/2"

art.nr.	mm	unit	ref.	kg.
S902270	35	20	blister	0,12

**Reparatiekoppeling 3/4"**  
Réparateur autoserrant 3/4"

art.nr.	mm	unit	ref.	kg.
S902271	50	10	blister	0,18

**Snelkoppeling 1/2"**  
Raccord rapide 1/2"

art.nr.	mm	unit	ref.	kg.
S902280	45	10	blister	0,12

**Snelkoppeling 3/4"**  
Raccord rapide 3/4"

art.nr.	mm	unit	ref.	kg.
S902281	50	10	blister	0,16



VRAC



BLISTER



BOX





Ipiere Kunststof / PVC



**Roll-matik 1/2 automatische roller**  
Roll-matik 1/2 enrouleur automatique

art.nr.	m	unit	ref.	kg.
S1900	20	1	blister	10



**Dubbele nippel**  
Mamelon double

art.nr.	mm	unit	ref.	kg.
S2005	60	20	blister	0,03
S2005S	60	1	single	0,03



**Y-vertakking met 3 nippels**  
Branchement Y avec 3 mamelons

art.nr.	mm	unit	ref.	kg.
S2007	65x75	1	blister	0,03



**Regelbare spuit**  
Lance réglable

art.nr.	mm	unit	ref.	kg.
S2009	140	20	blister	0,05
S2009BS	140	60	box	0,05



**Broeskop alu met verlengstuk**  
Pomme alu églable avec rallonge

art.nr.	mm	unit	ref.	kg.
S20712	750-1070	1	blister	0,5

**Nippel 1/2" mannelijk**  
Mamelon 1/2" mâle

art.nr.	mm	unit	ref.	kg.
S2200S	35	1	vrac	0,01

**Nippel 3/4" mannelijk**  
Mamelon 3/4" mâle

art.nr.	mm	unit	ref.	kg.
S2201S	40	1	vrac	0,01

**Nippel 1/2" vrouwelijk**  
Mamelon 1/2" femelle

art.nr.	mm	unit	ref.	kg.
S2203	35	10	blister	0,01

**Nippel 3/4" vrouwelijk**  
Mamelon 3/4" femelle

art.nr.	mm	unit	ref.	kg.
S2204	40	20	blister	0,01
S2204BS	40	100	box	0,01

**Nippel 1" vrouwelijk**  
Mamelon 1" femelle

art.nr.	mm	unit	ref.	kg.
S22042	40	25	blister	0,01
S22042BS	40	50	box	0,01

**Reductie 3/4" M - 1/2" F**  
Réduction 3/4" M - 1/2" F

art.nr.	mm	unit	ref.	kg.
S2205S	18	1	vrac	0,006



VRAC



BLISTER

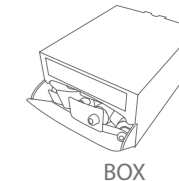

BOX







**Reparatiekoppeling 1/2" & 5/8"**  
Réparateur autoserrant 1/2" & 5/8"

art.nr.	mm	unit	ref.	kg.
S2270	55	20	blister	0,02
S2270BS	55	50	box	0,02



**Reparatiekoppeling 3/4"**  
Réparateur autoserrant 3/4"

art.nr.	mm	unit	ref.	kg.
S2271	65	10	blister	0,04



**Snelkoppeling 1/2" & 5/8"**  
Raccord rapide autoserrant 1/2" & 5/8"

art.nr.	mm	unit	ref.	kg.
S2280	60	20	blister	0,03
S2280BS	60	60	box	0,03



**Snelkoppeling 3/4"**  
Raccord rapide autoserrant 3/4"

art.nr.	mm	unit	ref.	kg.
S2281	65	10	blister	0,04
S2281BS	65	60	box	0,04



**Snelkoppeling 'aquastop' 1/2"**  
Raccord rapide 'aquastop' 1/2"

art.nr.	mm	unit	ref.	kg.
S2282	60	10	blister	0,06
S2282BS	60	50	box	0,06



**Snelkoppeling 'aquastop' 3/4"**  
Raccord rapide 'aquastop' 3/4"

art.nr.	mm	unit	ref.	kg.
S2283	65	10	blister	0,07



**Nippel met koppeling 1/2"**  
Mamelon autoserrant 1/2"

art.nr.	mm	unit	ref.	kg.
S2290	70	10	blister	0,05



**Nippel met koppeling 3/4"**  
Mamelon autoserrant 3/4"

art.nr.	mm	unit	ref.	kg.
S2291	75	10	blister	0,07



**Dichtingsring**  
Joint

art.nr.	Ø	unit	ref.	gr.
S2295S	1/2"	1	vrac 50pc	1
S2296S	3/4"	1	vrac 50pc	2
S2297S	1"	1	vrac 50pc	4
S2298S	O-ring	1	vrac 50pc	1
S2299	Mix: 1/2", 3/4" & O-ring	1	blister 10pc	30





**Pistolsproeier met regelbare lans**  
Pistolet avec lance réglable

art.nr.	mm	unit	ref.	kg.
S2378	170x195	10	blister	0,20



**Pistolsproeier met regelbare broeskop**  
Pistolet avec pomme à débit réglable

art.nr.	mm	unit	ref.	kg.
S2379	200x160	10	blister	0,26



**Wentelsproeier 'Alfa 14'**  
Arroseur rotatif 'Alfa 14'

art.nr.	mm	unit	ref.	kg.
S2481	370x135x120	10	blister	0,57

H<sub>2</sub>O 4 bar: 16x9 m



**Microfor 70x2600**  
Microfor 70x2600

art.nr.	m	unit	ref.	kg.
S2492	15	1	blister	1,5
S2493	50	1	blister	4



**Muurhaspel voor tuinslang**  
Dérouleur mural pour tuyau

art.nr.	mm	unit	ref.	kg.
S2510	250x165x145	1	blister	0,3



**Roterende sproeier 'Gamma'**  
Arroseur rotatif 'Gamma'

art.nr.	mm	unit	ref.	kg.
S2826	155x100x270	6	blister	0,44

H<sub>2</sub>O 4 bar: ø 10 m



**Roterende sproeier 'Bèta' op voetstuk**  
Arroseur rotatif 'Bèta' sur traîneau

art.nr.	mm	unit	ref.	kg.
S2864	210x95x280	6	blister	1,23

H<sub>2</sub>O ø 4 bar: 22 m



**Impulssproeier 'Bèta' S2064 op driepoot**  
Arroseur à impulsion 'Bèta' S2064 sur trepied

art.nr.	mm	unit	ref.	kg.
S2804	.	1	blister	1,5



**Impulssproeier 'Bèta' S2063 op driepoot**  
Arroseur à impulsion 'Bèta' S2063 sur trepied

art.nr.	mm	unit	ref.	kg.
S2805	.	1	blister	1,7

H<sub>2</sub>O ø 4 bar: 24 m







Druksproeiers / pulvérisateurs à pression



**Plantenverstuiver capaciteit 1L**

Pulvérisateur à gâchette capacité 1L

art.nr.	mm	unit	ref.	kg.
S37010	100x100x300	1	vrac	0,11

**Druksproeier capaciteit 2L**

Pulvérisateur à pression capacité 2L

art.nr.	mm	unit	ref.	kg.
S37020	160x160x330	1	vrac	0,51

**Druksproeier capaciteit 5L**

Pulvérisateur à pression capacité 5L

art.nr.	mm	unit	ref.	kg.
S37050	180x190x440	1	vrac	1,8

**Druksproeier capaciteit 8L**

Pulvérisateur à pression capacité 8L

art.nr.	mm	unit	ref.	kg.
S37080	180x180x550	1	vrac	1,9

**Drukruksproeier capaciteit 16L**

Pulvérisateur dorsal à pression capacité 16L

art.nr.	mm	unit	ref.	kg.
S37160	440x160x500	1	vrac	4,9

Caddy's . Chariots

15

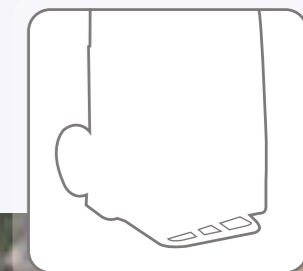





**Wheely - wagentje**

Chariot Wheely

art.nr.	mm	unit	ref.	kg.
WH100	460x460x860	1	vrac	11,5

**Tuinafvalzak voor Wheely (175L)**

Sac de jardin pour Wheely (175L)

art.nr.	mm	unit	ref.	kg.
WH200	400x470x890	1	vrac	0,7

**Tuinafvalzak zelf-staand (350L)**

Sac de jardin autoportant (350L)

art.nr.	mm	unit	ref.	kg.
WH201	700x700x700	1	-	1,32

**Tuinafvalzak zelf-staand (500L)**

Sac de jardin autoportant (500L)

art.nr.	mm	unit	ref.	kg.
WH202	800x800x800	1	-	1,55

**Pop up afvalzak 120L**

Sac à déchets pop up 120L

art.nr.	mm	unit	ref.	kg.
S3620	ø 450x750	24	vrac	0,6

**Caddy + Tuinafvalzak WH200 (175L)**

Caddy + Sac de jardin WH200 (175L)

art.nr.	mm	unit	ref.	kg.
CC100	560x500x990	1	vrac	4,1

**Draadkar galva met 2 volle wielen**

Chariot métal galva avec 2 roues pleines

art.nr.	cm	unit	ref.	kg.
CC200	65x92x60	1	vrac	15

binnenmaat bak: 61x84x19 cm



**Compostbak zwart 400L**

Compostage noir 400L

art.nr.	cm	unit	ref.	kg.
CC400	80x90x90	1	-	6



**Herby: mobiele kruidentuin**

Herby: table à potager mobile

art.nr.	cm	unit	ref.	kg.
CC300	65x123x130	1	-	27

capaciteit: 120L  
afmetingen verpakking: 118x71x12 cm







Starko

**Grondwerkersspade**

Louchet terrasière

art.nr.	mm	unit	ref.	kg.
STK103.T34	340x140	5	M101.2STK	2,25
STK103.T40	380x140	5	M101.2STK	2,25



**Spade Senlis zwart gelakt met open dul**

Bêche Senlis noir vernie à douille ouverte

art.nr.	mm	unit	ref.	kg.
106.TZ	280x170	5	M101.5	1,50



**Gazonafboorder halve maan**

Coupe bordures demi-lune

art.nr.	mm	unit	ref.	kg.
STK404.1T	180x900	5	-	1



**Zandschop nr. 2 met beuken steel**

Pelle à sable n° 2 avec manche en hêtre

art.nr.	mm	unit	ref.	kg.
STK700.2B	240x370	5	M104.2	2







17



**Dubbele hark hartvorm essen steel 400mm**  
Pioche manche en frêne 400mm

art.nr.	mm	kg.
DE3082	400x230x65	0,5

**Cultivator 3-tands essen steel 1400mm**  
Cultivateur 3 dents manche en frêne 1400mm

art.nr.	mm	kg.
DE3054	1550x80x50	0,56

**Rondschoffel essen steel 1400mm**  
Binette forme ronde manche en frêne 1400mm

art.nr.	mm	kg.
DE3072	1570x70x50	0,54

**Tegelritzer essen steel 1400mm**  
Racloir manche en frêne 1400mm

art.nr.	mm	kg.
DE9700	1510x60x60	0,6

**Hartschoffel gesmeed essen steel 1400mm**  
Binnette à main forgée manche en frêne 1400mm

art.nr.	mm	kg.
DE3460	1610x105x65	0,57

**Onkruidkrabber essen steel 1400mm**  
Grattoir manche en frêne 1400mm

art.nr.	mm	kg.
DE9901	1505x100x30	0,48

**Handhakje gesmeed 10cm essen steel 1400mm**  
Serfouette forgée 10cm manche en frêne 1400mm

art.nr.	mm	kg.
DE3461	1570x100x35	0,55

**Spork schoffel 10cm essen steel 1700mm**  
Binette Spork 10cm manche en frêne 1700mm

art.nr.	mm	kg.
DE8325	1900x100x170	1,12







**Hartschoffel 16cm essen steel 1700mm**

Binette forme coeur 16cm manche en frêne 1700mm

art.nr.	mm	kg.
DE3216S	1900x160x55	1,21

**Hak halve maan 16cm essen steel 1700mm**

Binette demi lune forgée 16cm manche en frêne 1700mm

art.nr.	mm	kg.
DE3516S	1900x160x43	1,2

**Spork hak essen steel 1700mm**

Houe spork manche en frêne 1700mm

art.nr.	mm	kg.
DE8310	100x170	1,24

**Midispork met huis essen T-steel 800mm**

Midispork manche T en frêne 800mm

art.nr.	mm	kg.
DE8331	100x170	1,1

**Plantschepje gesmeed essen handvat 140mm**

Transplantoir forgé manche en frêne 140mm

art.nr.	mm	kg.
DE3000	330x80x50	0,24

**Verplantschepje gesmeed essen handvat 140mm**

Transplantoir forgé manche en frêne 140mm

art.nr.	mm	kg.
DE3002	340x60x50	0,21

**Handspade essen steel 800mm**

Bêche manche en frêne 800mm

art.nr.	mm	kg.
DE3092	910x110x170	0,8

**Handgriepje essen steel 800mm**

Fourche à bêcher manche en frêne 800mm

art.nr.	mm	kg.
DE3095	910x110x170	0,72

**Handspade essen steel 400mm**

Bêche manche en frêne 400mm

art.nr.	mm	kg.
DE3093	510x110x170	0,66

**Paardebloemwieder essen T-steel 800mm**

Sarcleur à pissenlits manche T en frêne 800mm

art.nr.	mm	kg.
DE8666	970x120x50	0,54

**Bladhark essen steel 1400mm**

Balai à feuilles manche en frêne 1400mm

art.nr.	mm	kg.
DE1112	160x1750	1,3

**Handgriepje essen steel 400mm**

Poignée manche en frêne

art.nr.	mm	kg.
DE3094	510x110x170	0,46

**Plantgraafje/koolplantschopje essen T-steel 400mm**

Plantoir à vivaces manche T en frêne 400mm

art.nr.	mm	kg.
DE2009	525x115x115	0,42

**Bollenplanter met 2 essen stelen 750mm**

Plantoir bulbes avec 2 manches en frêne 750mm

art.nr.	mm	kg.
DE3065	1100x140x75	1,66

**Handhakje gesmeed 10cm essen handvat**

Serfouette forgée 10cm manche en frêne

art.nr.	mm	kg.
DE3446	310x100x35	0,2

**Handspork essen handvat 140mm**

Transplantoir spork manche en frêne 140mm

art.nr.	mm	kg.
DE8330	80x120	0,22





**Hartschoffel gesmeed essen handvat 140mm**  
Binette forme coeur forgée manche en frêne 140mm

art.nr.	mm	kg.
DE3444	350x105x65	0,22

**Tegelritzer essen handvat 140mm**  
Racloir manche en frêne 140mm

art.nr.	mm	kg.
DE0303	250x60x60	0,13

**Plantguts essen handvat 140mm**  
Tire-racine manche en frêne 140mm

art.nr.	mm	kg.
DE3039	380x30x30	0,23

**Rondschoffel essen handvat 140mm**  
Binette forme ronde manche en frêne 140mm

art.nr.	mm	kg.
DE3070	310x70x50	0,18

**Cultivator spring tine essen handvat 140mm**  
Cultivateur spring tine manche en frêne 140mm

art.nr.	mm	kg.
DE3055	270x65x60	0,09

**Bio handhakje essen handvat 140mm**  
Serfouette bio manche en frêne 140mm

art.nr.	mm	kg.
DE3450	330x75x60	0,18

**Bio cultivator 3-tands essen handvat 140mm**  
Cultivateur bio 3 dents manche en frêne 140mm

art.nr.	mm	kg.
DE3451	330x60x60	0,14

**Japanse handhak essen handvat 140mm**  
Rasoir houe Japonaise manche en frêne 140mm

art.nr.	mm	kg.
DE2901	320x120x30	0,14

**Onkruidmes essen handvat 140mm**  
Couteau-émousseur manche en frêne 140mm

art.nr.	mm	kg.
DE3059	280x80x30	0,12

**Cultivator 3-tands essen handvat 140mm**  
Cultivateur 3 dents manche en frêne 140mm

art.nr.	mm	kg.
DE3051	290x80x50	0,18

**Bollenplanter essen handvat 140mm**  
Plantoir à bulbes manche en frêne 140mm

art.nr.	mm	kg.
DE3048	280x40x40	0,19

**Plantstok**  
Plantoir

art.nr.	mm	kg.
DE3087	290	0,14

**Dubbele hak recht essen steel 400mm**  
Serfouette à fleurs double droitier manche en frêne 400mm

art.nr.	mm	kg.
DE3083	400x230x65	0,47

**Spats essen steel 1100mm met opstapjes**  
Spats manche en frêne 1100mm avec marche-pied

art.nr.	mm	kg.
DE20360	275x215	1,8

**Zwanehals spade essen steel 750mm met opstapjes**  
Bêche cou de cygne manche en frêne 750mm avec marche-pied

art.nr.	mm	kg.
DE20510	160x250	2,1

**Shark spade met zwanehals essen steel 750mm met opstapjes**  
Bêche 'requin' avec cou de cygne manche en frêne 750mm avec marche-pied

art.nr.	mm	kg.
DE83080	1120x160x240	2





**Beugelhark essen steel 1400mm**

Râteau-étrier manche en frêne 1400mm

art.nr.	mm	kg.
DE3863S	1600x340x90	1,62

**Roosvork essen steel 900mm**

Fourche à rosier manche en frêne 900mm

art.nr.	mm	kg.
DE5107	1155x150x50	1,24

**Bio paardebloemsteker essen handvat 140mm**

Coupe-pissenlits bio manche en frêne 140mm

art.nr.	mm	kg.
DE3454	365x25x30	0,14

**Midispork met huis essen T-steel 400mm**

Midispork manche T en frêne 400mm

art.nr.	mm	kg.
DE8329	100x170	1

**Spork essen steel T-greep 900mm**

Spork manche T en frêne 900mm

art.nr.	mm	kg.
DE8300	155x250	1,5

**Graskantsteker gesmeed essen steel 850mm**

Coupe-bordures forgé manche en frêne 850mm

art.nr.	mm	kg.
DE9101	990x240x30	1

**Plantijzer essen handvat 140mm**

Plantoir manche en frêne 140mm

art.nr.	mm	kg.
DE3057	310x30x30	0,22

**Tulpschepje essen handvat 140mm**

Plantoir tulipe manche en frêne 140mm

art.nr.	mm	kg.
DE3034	315x80x50	0,21

**Rock 'n Root plantschepje gesmeed essen handvat 140mm**

Plantoir désherbeur Rock 'n Root forgé manche en frêne 140mm

art.nr.	mm	kg.
DE3032	280x40x40	0,19

**Potschepje essen handvat 140mm**

Plantoir potée manche en frêne 140mm

art.nr.	mm	kg.
DE3049	280x100x50	0,21

**Handvorkje groot gesmeed essen handvat 140mm**

Fourche à fleurs grande forgée manche en frêne 140mm

art.nr.	mm	kg.
DE3004	290x80x45	0,2

**Wiedvork 2-tands essen handvat 140mm**

Serfouette 2 dents manche en frêne 140mm

art.nr.	mm	kg.
DE3098	300x40x30	0,2

**Cape Cod wieder rechts essen handvat 140mm**

Désherbeur Cape Cod droitier manche en frêne 140mm

art.nr.	mm	kg.
DE3097	290x100x30	0,2

**Onkruidkrabber essen handvat 140mm**

Grattoir manche en frêne 140mm

art.nr.	mm	kg.
DE9898	245x100x30	0,15

**Bollenplanter met houten handgreep**

Plantoir à bulbes avec poignée en bois

art.nr.	mm	kg.
DE3047	270x70x145	0,64

**Display hout wit gepersonaliseerd**

Display bois blanche personnalisé

art.nr.	mm	kg.
DE0001	.	.









anno 1873



ANNO 1873  
**DE PYPERE**  
MADE IN BELGIUM

Melkerijstraat 1a  
8850 Ardoorie  
België - Belgique  
T. +32 51 74 43 82  
F. +32 51 74 72 09